



# Twist™ 3D .40 ARF

## ASSEMBLY MANUAL



### HAN2660

© 2010 Horizon Hobby, Inc.  
4105 Fieldstone Road  
Champaign, IL 61822  
USA

Horizon Hobby UK  
Units 1-4, Ployters Road  
Staple Tye  
Harlow, Essex  
CM18 7NS  
United Kingdom

Horizon Hobby Deutschland GmbH  
Hamburger Strasse 10  
25335 Elmshorn  
Germany

Hangar 9® products are distributed exclusively by Horizon Hobby, Inc.

DSM and DSM2 are trademarks or registered trademarks of Horizon Hobby, Inc. The Spektrum trademark is used with permission of Bachmann Industries, Inc. Spektrum radios and accessories are exclusively available from Horizon Hobby, Inc.

Revised 11/09  
6369.1

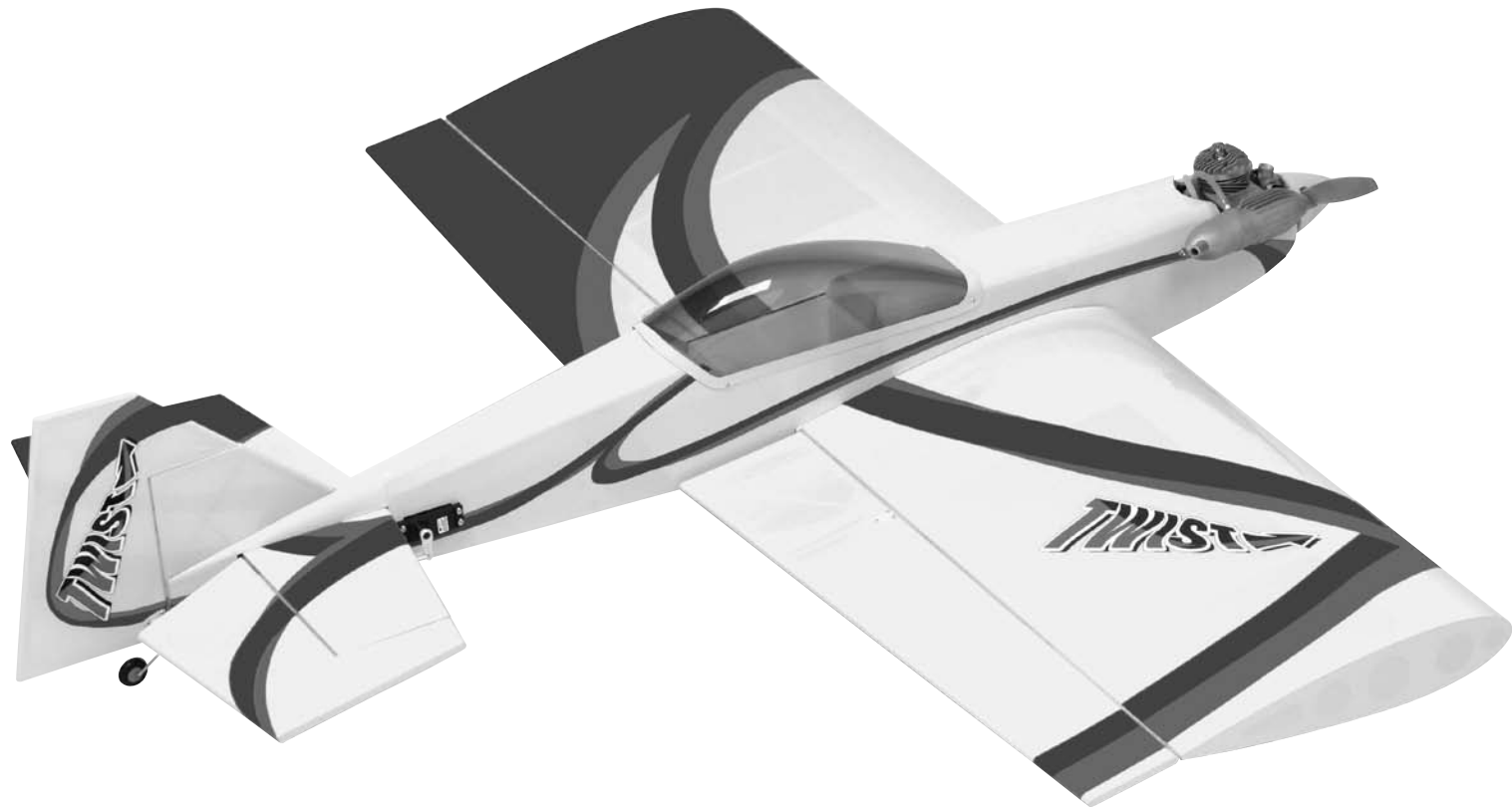

- Great sport 3D performer
- Covered in genuine UltraCote®

### Specifications

Wingspan: .....	47.75 in (1212.85mm)	Engines: .....	40-.52 2-stroke/56-.82 4-stroke
Length:.....	48.38 in (1228.73mm)	Radio:.....	.4-channel with 5 servos
Wing Area:.....	747.37 sq in (48.2 sq dm)		
Weight:.....	.5.0-6.0 lb (2.27 kg-2.72 kg)		

# Table of Contents

Covering Colors .....2

Contents of Kits .....3

Required Radio and Engine .....3

Field Equipment Required .....4

Additional Required Tools and Adhesives .....4

Warning.....4

Before Starting Assembly.....5

Using the Manual.....5

Section 1: Attaching the Wing to the Fuselage .....6

Section 2: Horizontal Stabilizer Installation.....7

Section 3: Vertical Stabilizer Installation.....9

Section 4: Ailerons Installation .....10

Section 5: Elevators Installation .....12

Section 6: Tailwheel Installation .....14

Section 7: Rudder Installation .....15

Section 8: Engine Installation .....16

Section 9: Throttle Pushrod Installation .....17

Section 10: Fuel Tank Installation.....19

Section 11: Landing Gear Installation.....20

Section 12: Radio Installation.....21

Section 13: Linkage Installation .....24

Section 14: Canopy Installation .....29

Adjusting the Engine .....30

Control Throws .....30

Recommended CG.....30

Preflight.....31

Range Testing the Radio .....31

2010 Official Academy of Model Aeronautics Safety Code .....32

Warranty Information.....33

Instructions for Disposal of WEEE by Users in the European Union.....35

## Covering Colors

- Cream HANU878
- Sky Blue HANU875
- Flame Red HANU883

# Contents of Kits

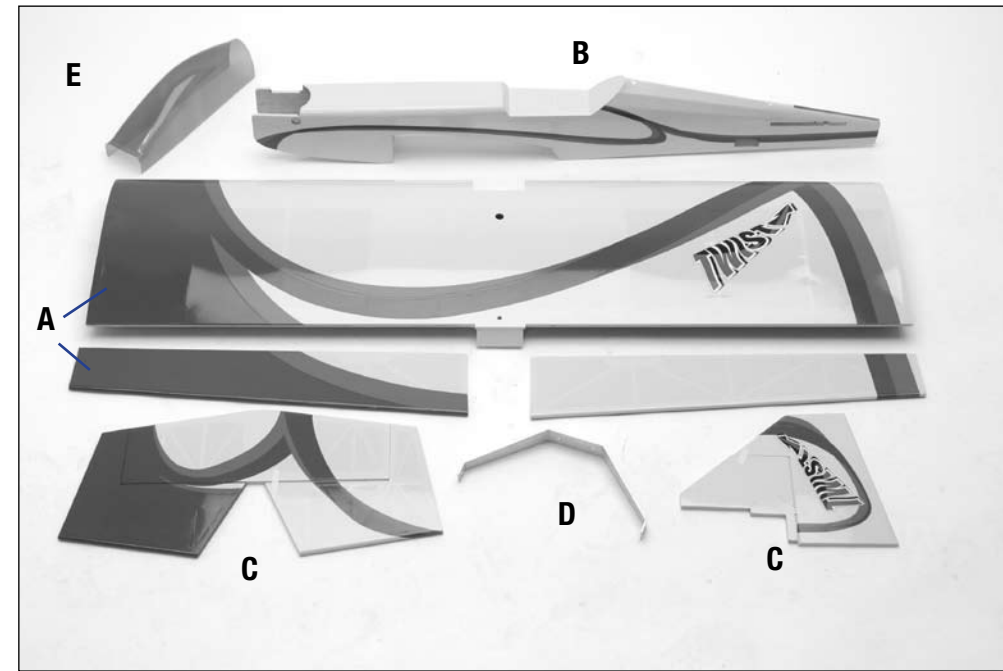

### Large Parts:

- A. Wing Set HAN266001
- B. Fuselage HAN266002
- C. Tail Set HAN266003
- D. Landing Gear HAN266004
- E. Canopy HAN266006

### Items Not Shown:

- 2 3/4 in Wheels HAN305
- Fuel Tank HAN266007
- Engine Mount HAN266008
- Decal Set HAN266005
- Tailwheel Assembly HAN266009
- Control Hardware Set HAN266010

## Required Radio and Engine

### Radio Equipment

- 4-channel radio system (minimum)
- 5 standard servos (JRPS821 recommended or equivalent)
- 12-inch servo extension (JRPA098) (2)
- Large servo arm (JRPA212) (2)
- Y-harness (JRPA1350) or 3-inch servo extension (JRPA093) (2)
- Radio switch (JRPA003)

### Recommended Engines

- .40-.52 2-stroke (EVOE0461 or EVOE0520)
- .56-.82 4-stroke

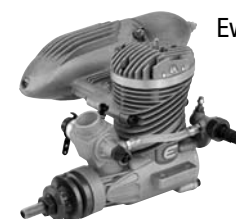

Evolution® .46NX  
EVOE0461



Saito™ .72 AAC  
SAIE072B

### Recommended Radio Systems

- Spektrum™ DX5e DX7
- Spektrum DX6i
- Spektrum DX7
- JR® 9303
- JR 12X



JR 9303



# Field Equipment Required

- Propeller (2-stroke (EVO11050) 4-stroke (EVO13080))
- Fuel
- Glow Plug Wrench (HAN2510)
- 12-Volt Starter (HAN162)
- Glow Plug Igniter with Charger (HAN7101)
- Glow Plug (EVOGP1/HAN3011)
- Manual Fuel Pump (HAN118)

# Additional Required Tools and Adhesives

## Tools:

- Canopy scissors
- Drill
- Drill bits: 1/16-inch, 3/32-inch, 1/8-inch, 9/64-inch, 5/32-inch
- Felt-tipped pen
- Flat blade screwdriver
- Foam: 1/2-inch
- Hobby knife
- Making tape
- Paper towels
- Petroleum jelly
- Phillips screwdriver (large)
- Phillips screwdriver (small)
- Pliers
- Rubbing alcohol
- Ruler
- Sandpaper
- Soldering iron
- Square
- T-pins

## Adhesives:

- 6-minute epoxy (PAAPT38)
- 30-minute epoxy (PAAPT39)
- Thin CA (PAAPT07)
- Medium CA (PAAPT01)
- CA remover/debonder (PAAPT16)
- Masking tape (MMM20901)
- Canopy glue (Formula 560)

## Other Required Items:

- 2 ¼-inch spinner (Red, DUB280)
- Epoxy brushes (DUB345)
- File
- Measuring device (e.g. ruler, tape measure)
- Mixing sticks for epoxy (DUB346)
- Paper towels
- Rubbing alcohol
- Wax paper

# Before Starting Assembly

Before beginning the assembly of your Twist, remove each part from its bag for inspection. Closely inspect the fuselage, wing panels, rudder, and stabilizer for damage. If you find any damaged or missing parts, contact the place of purchase.

If you find any wrinkles in the covering, use a heat gun or covering iron to remove them. Use caution while working around areas where the colors overlap to prevent separating the colors.



HAN100 – Heat Gun



HAN135 – Pro-Seal  
Covering Iron

# Using the Manual

This manual is divided into sections to help make assembly easier to understand and to provide breaks between each major section. In addition, check boxes have been placed next to each step to keep track of each step completed. Steps with two boxes indicate the step will require repeating, such as for a right or left wing panel, two servos, etc. Remember to take your time and follow the directions.

# Warning

An RC aircraft is not a toy. If misused, it can cause serious bodily harm and damage to property. Fly only in open areas, preferably at AMA (Academy of Model Aeronautics) approved flying sites, following all instructions included with your radio and engine.

**Age Recommendation: 14 years or over. Not a toy. Not intended for use by children without direct adult supervision.**

# Section 1: Attaching the Wing to the Fuselage

**Required Parts**

- Wing
- Fuselage
- 1/4 x 1 3/4-inch wing dowel
- 1/4-20 x 2-inch nylon bolt

**Required Tools and Adhesives**

- 6-minute epoxy
- Sandpaper
- Flat blade screwdriver

**Step 1**

Locate the 1/4 x 1 3/4-inch wing dowel. Sand a small taper on one end of the dowel to make it easier to attach the wing to the fuselage.

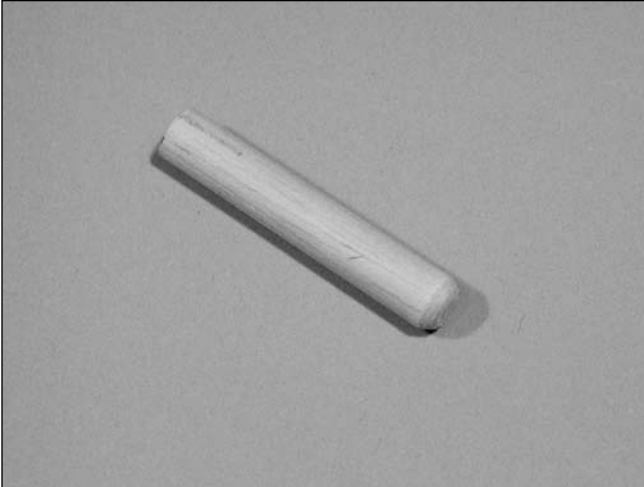

**Step 2**

Glue the dowel into the wing using 6-minute epoxy. Make sure there is about 1/2-inch of the dowel exposed.

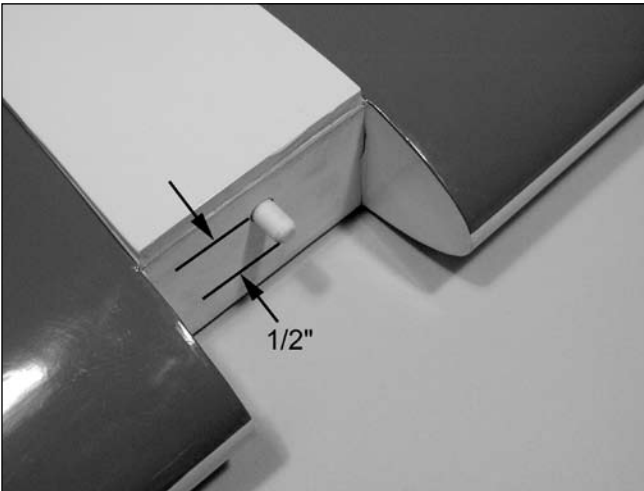

**Step 3**

Place the wing onto the fuselage. Secure the wing using the 1/4-20 x 2-inch nylon bolt.



# Section 2: Horizontal Stabilizer Installation

**Required Parts**

- Wing
- Fuselage
- Horizontal stabilizer
- Elevator joiner wire

**Required Tools and Adhesives**

- Flat blade screwdriver
- Sandpaper
- Felt-tipped pen
- Paper towel
- Rubbing alcohol

**Step 1**

Slide the stab into the slot in the fuselage, with the leading edge pushed forward in the slot. Center the stab in the opening by measuring the distance from the fuselage to each tip. The stab is aligned when both measurements are identical.

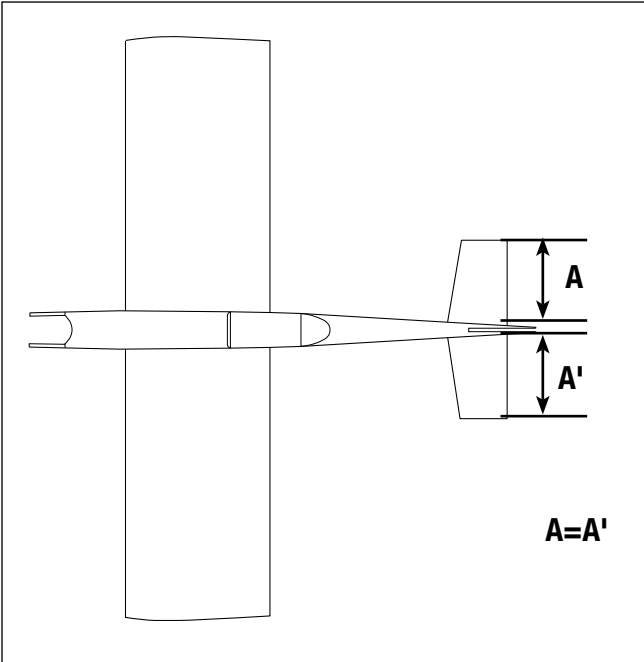

**Step 2**

Check the distance from each stab tip to each wing tip. These measurements must also be equal.

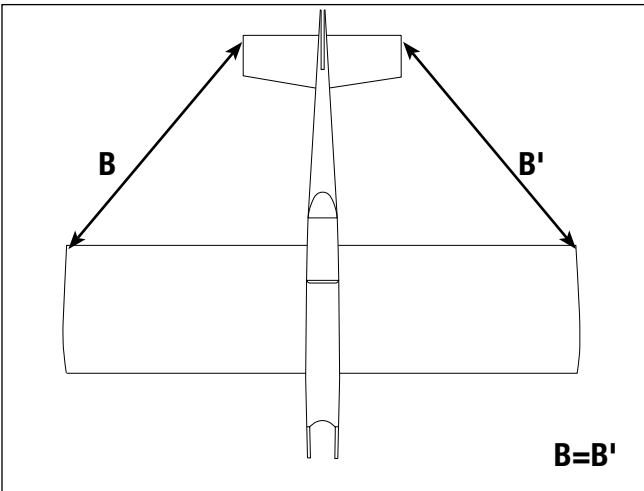

**Step 3**

The last alignment step is making sure the wing and stabilizer are parallel. If they are not, lightly sand the opening in the fuselage for the stab until the stab rests parallel to the wing.

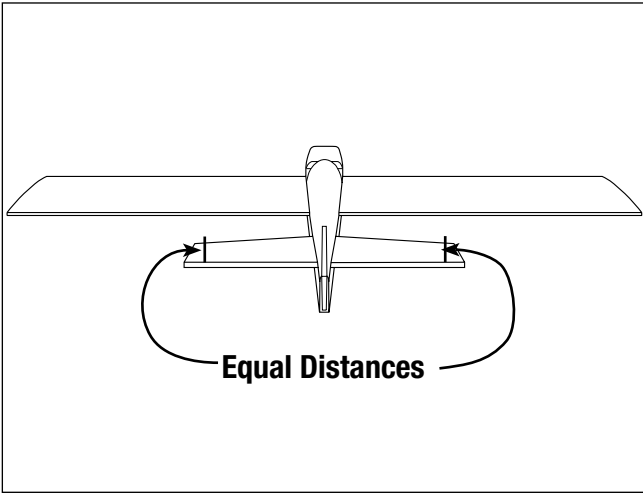

**Step 4**

Use a felt-tipped pen to trace the outline of the fuselage on the top and bottom of the stab.

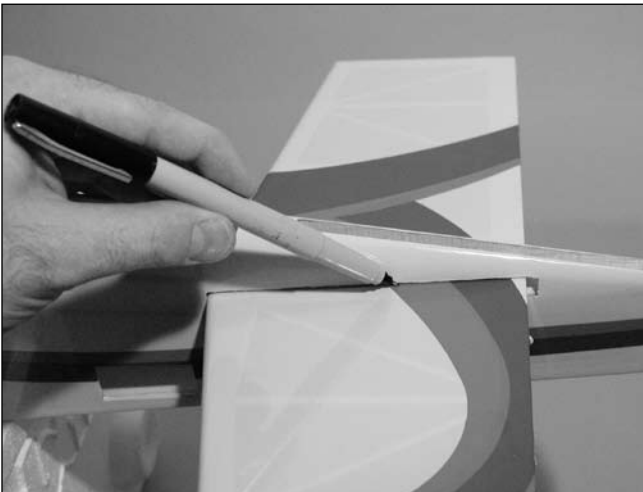

## Section 2: Horizontal Stabilizer Installation (continued)

### Step 5

Remove the stab and use a hobby knife with a brand new blade to remove the covering 1/16-inch inside the lines just drawn.

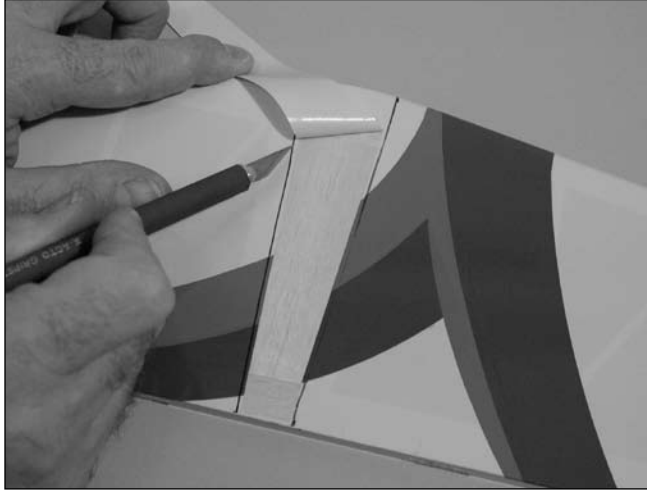

**Note:** DO NOT cut into the underlying wood. Let the knife “float” across the covering. Cutting into the wood will weaken the stabilizer and may cause it to fail in flight.

**Hint:** You can use a soldering iron instead of a hobby knife to remove the covering. Doing so will eliminate accidentally cutting into the stabilizer.

### Step 6

Place the elevator joiner wire into the slot for the stab. Reposition the stab into the fuselage. It may be necessary to trim the opening at the rear to allow for clearance for the joiner wire.



**Hint:** Use a little rubbing alcohol and a paper towel to remove the felt-tipped marker lines once they are no longer needed.

### Step 7

Slide the stabilizer from the fuselage far enough to expose the uncovered area. Mix 1/2 ounce of 30-minute epoxy. Apply the epoxy to the exposed area on both the top and bottom of the stab. Slide the stab back into position and double-check the alignment of the stab. Remove any excess epoxy using a paper towel and rubbing alcohol.



**Hint:** Use a little masking tape to keep the joiner wire out of the way until it's time to install the elevators. Also make sure there is no epoxy on the joiner wire.

## Section 3: Vertical Stabilizer Installation

### Required Parts

- Wing
- Fuselage
- Vertical stabilizer

### Required Tools and Adhesives

- 30-minute epoxy
- Sandpaper
- Square
- Ruler
- Felt-tipped pen

### Step 1

Locate the vertical stabilizer (fin) and slide it into position. Position the fin so it is fully forward in the slot in the fuselage.

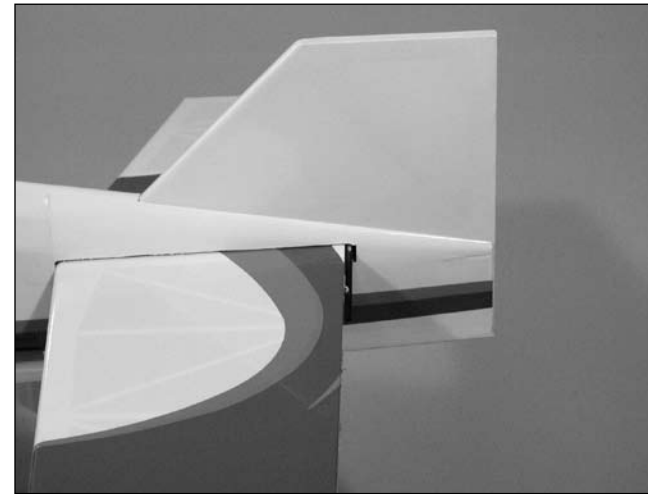

### Step 2

Check the alignment between the fin and stab. The fin must be 90-degrees to the stab to be in alignment. Sand the opening in the fuselage if necessary to get the perfect alignment.



### Step 3

Trace the outline of the fuselage onto the fin.

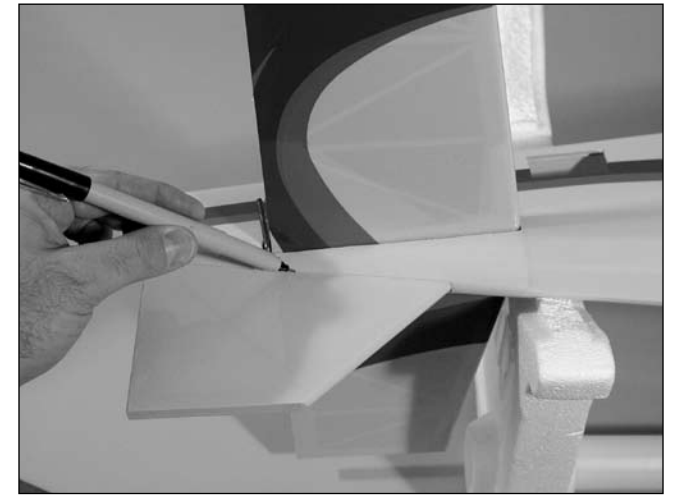

### Step 4

Remove the covering 1/16-inch below the line drawn in the last step.

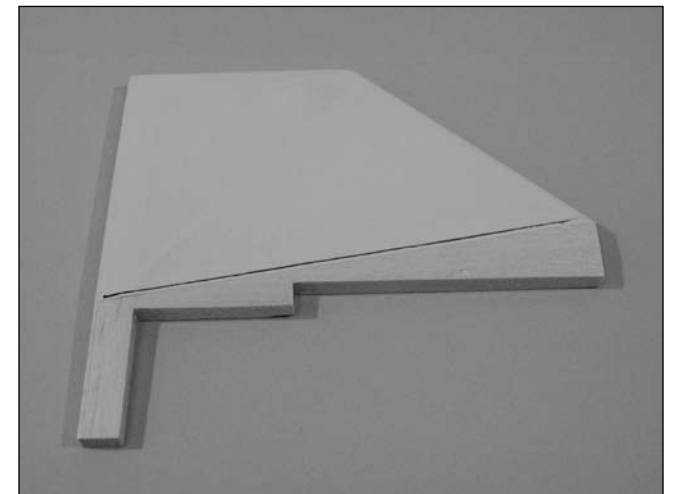

### Step 5

Mix 1/2 ounce of 30-minute epoxy. Apply the epoxy to the tab on the fin and to the area on the top of the fuselage where the covering was removed. Position the fin in the slot and check the alignment. Use masking tape to hold the fin in position until the epoxy fully cures.

**Hint:** Use rubbing alcohol and a paper towel to clean up any excess epoxy.

## Section 4: Ailerons Installation

### Required Parts

- Wing
- CA hinge (8)
- Aileron (left and right)

### Required Tools and Adhesives

- Thin CA
- T-pins

#### Step 1

Locate 8 of the CA hinges. Place a T-pin in the center of four of the hinges.

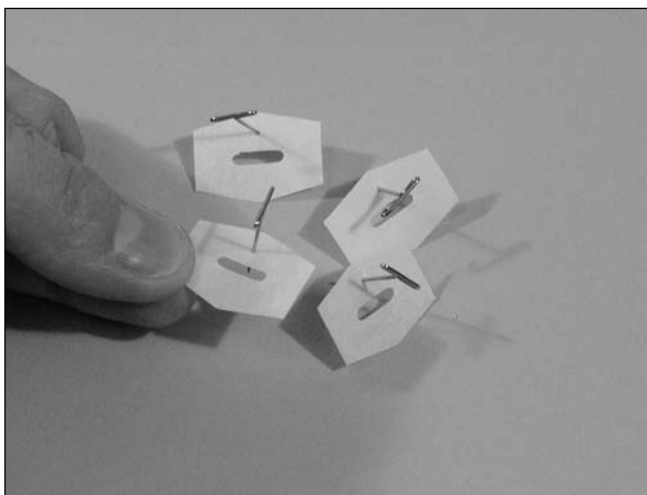

#### Step 2

Place the hinges in the precut slots in the aileron (or wing if you prefer). The T-pin will rest against the edge when installed correctly.

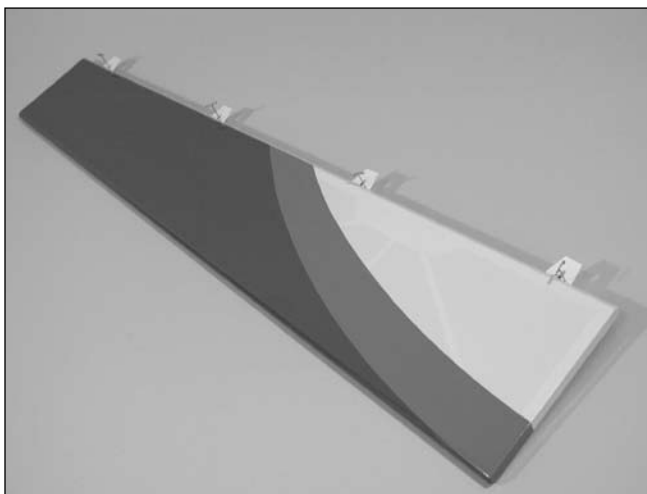

#### Step 3

Slide the aileron and wing together. The gap between the aileron and wing should be infinitely small, approximately 1/64-inch.

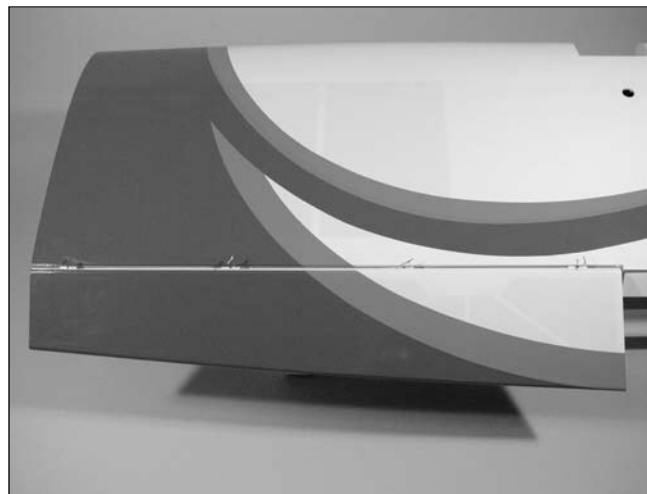

Hint: Be careful of the T-pins, as they can be sharp.

#### Step 4

Use a ruler to align the end of the aileron to the wing.



Note: Do not use CA accelerator during the hinging process. The CA must be allowed to soak into the hinge to provide the best bond. Using accelerator will not provide enough time for this process.

## Section 4: Ailerons Installation (continued)

#### Step 5

Remove the T-pins and apply thin CA to each hinge. Make sure the hinge is fully saturated with CA. Use a paper towel and CA remover/debonder to clean up any excess CA from the wing and/or aileron.

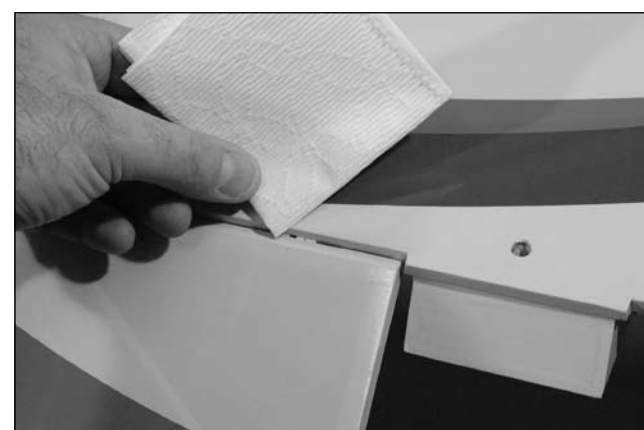

#### Step 6

Firmly grasp the wing and aileron and gently pull on the aileron to ensure the hinges are secure and cannot be pulled apart. Use caution when gripping the wing and aileron to avoid crushing the structure.



#### Step 7

Work the aileron up and down several times to work in the hinges and check for proper movement.



#### Step 8

Repeat Steps 1 through 7 for the remaining aileron.

# Section 5: Elevators Installation

**Required Parts**

- Fuselage assembly
- Elevator (left and right)
- Elevator joiner wire
- CA hinge (6)

**Required Tools and Adhesives**

- Thin CA
- 30-minute epoxy
- Drill
- Ruler
- T-pins
- Sandpaper
- Drill bit: 9/64-inch

**Step 1**

Locate three CA hinges. Place a T-pin in the center of the hinges. Place the hinges into the elevator half.

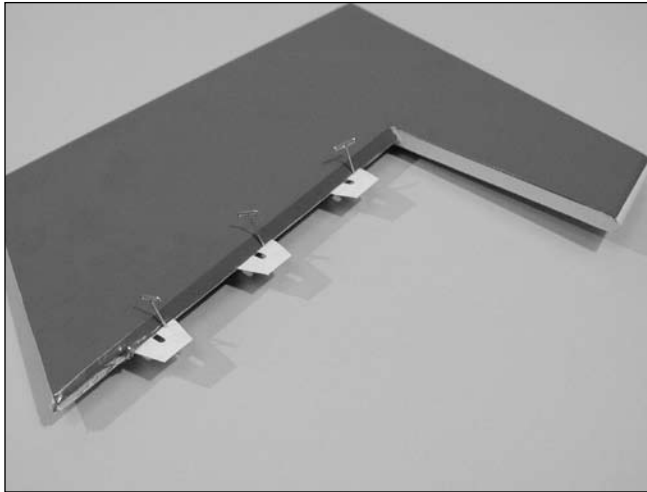

**Step 2**

Test fit the elevator and stab together. The elevator joiner wire will be inserted into the pre-drilled hole.



**Step 3**

Mix 1/2 ounce of 30-minute epoxy and apply it to the groove and hole in the elevator half. Insert the elevator joiner wire. Remove any excess epoxy using rubbing alcohol and a paper towel.

Note: You can combine this step with the following step if you like. This will hold the elevator in position while the epoxy cures.

**Step 4**

Check to make sure the elevator moves freely. It should not rub against the stabilizer at the tip. Check to make sure the hinge gap between the elevator and stabilizer is roughly 1/64-inch. Apply thin CA to both sides of the hinge. Make sure to saturate the hinge and don't use accelerator.

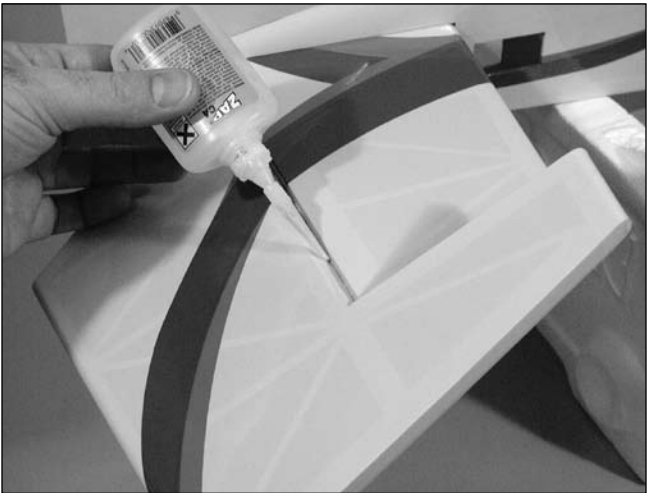

# Section 5: Elevators Installation (continued)

**Step 5**

Once the CA and epoxy have fully cured, gently pull on the elevator and stab to make sure the hinges are well glued. Flex the elevators a few times to break in the hinges.

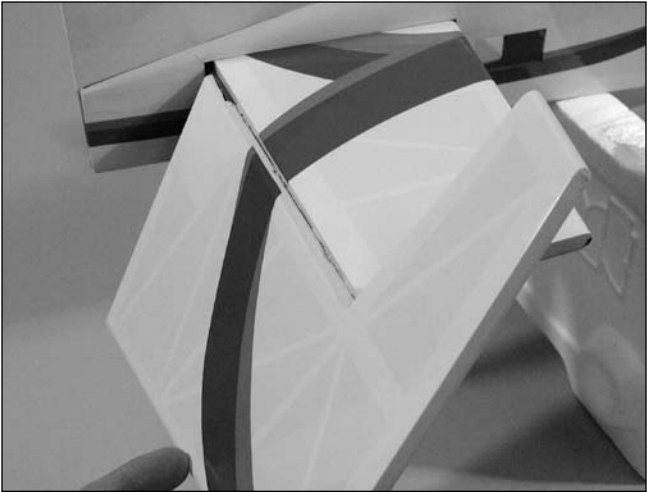
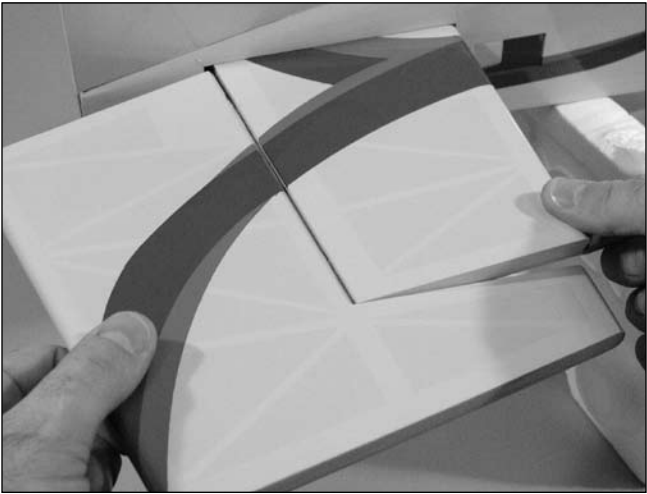

## Section 6: Tailwheel Installation

### Required Parts

- Rudder
- Tailwheel assembly

### Required Tools and Adhesives

- Hobby knife
- 6-minute epoxy
- Drill
- Drill bit: 5/64-inch (2mm)
- Paper towel
- Rubbing alcohol

#### Step 1

Locate the pre-drilled hole in the bottom of the rudder. This is the hole for the vertical shaft of the tailwheel assembly.



#### Step 2

Temporarily mount the tailwheel assembly to the bottom of the rudder. Do not glue at this time. Slide the nylon tailwheel support brackets to be evenly spaced along the tailwheel wire.



#### Step 3

Mark where you drill the two locations for the tailwheel support.

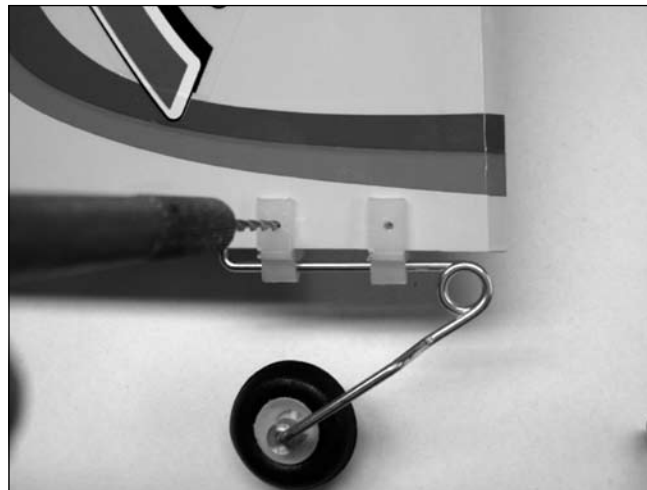

#### Step 4

Drill through the bottom of the rudder with the 5/64-inch (2mm) drill.

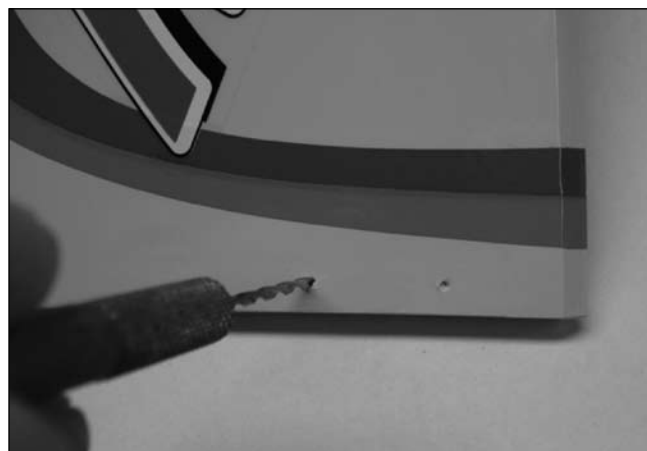

#### Step 5

Mix up a small batch of 6-minute epoxy. Using a toothpick insert a small amount of the epoxy in the hole in the bottom of the rudder. Insert the vertical tailwheel wire into the hole with the epoxy and mount the nylon brackets to the rudder with the hardware included.



## Section 7: Rudder Installation

### Required Parts

- Fuselage assembly
- Rudder
- CA hinge (3)

### Required Tools and Adhesives

- Thin CA
- T-pins
- 6-minute epoxy

#### Step 1

Locate the last three CA hinges, and place T-pins in the center, as done for the ailerons and elevator.

#### Step 2

Install the hinges in the rudder.

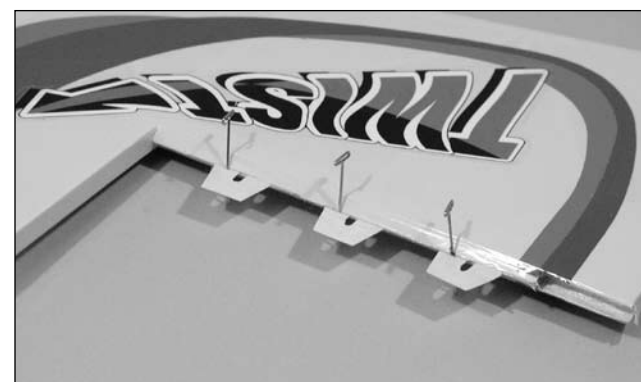

#### Step 3

Test fit the rudder to the fuselage. Make sure the rudder will rest tight against the fin and fuselage.



#### Step 4

Check to make sure the rudder moves freely. It should not rub against the fin at the tip. Apply thin CA to both sides of the hinge. Make sure to saturate the hinge, and don't use accelerator. Use a paper towel and CA debonder/remover to clean up any excess CA.



#### Step 5

Once the CA and epoxy have fully cured, give the rudder and fin the tug test to make sure the hinges are well glued. Flex the rudder a few times to break in the hinges.



## Section 8: Engine Installation

### Required Parts

- Fuselage assembly
- Engine mount
- 4mm x 20mm screw (4)
- 4mm washer (4)
- 4mm x 25mm screw (4)
- 4mm lock nut (4)

### Required Tools and Adhesives

- Drill
- Engine
- Clamp
- Drill bit: 11/64-inch (4.5mm)
- Pliers
- Phillips screwdriver (large)

#### Step 1

Attach the engine mount to the firewall using four 4mm x 20mm screws.



#### Step 2

Position the engine on the mount. Adjust the engine so the distance from the firewall to the drive washer is 4 1/4-inch. Use clamps to hold the engine in position.

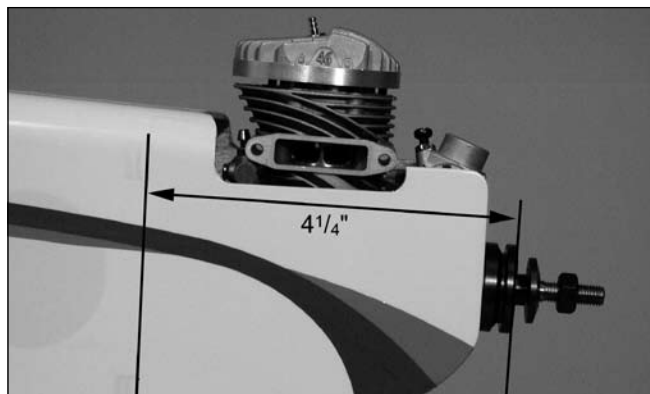

#### Step 3

Mark the locations for the engine mounting bolts.

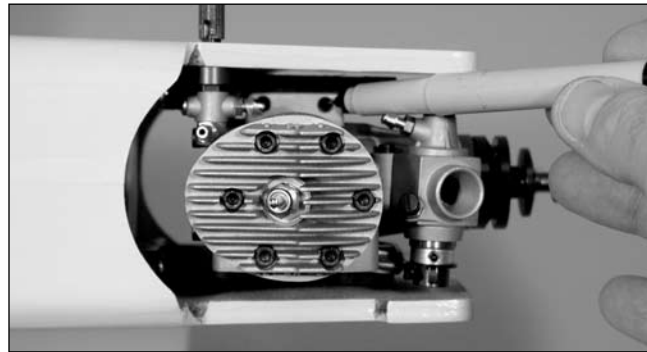

#### Step 4

Remove the engine and drill the locations marked in the previous step using a 11/64-inch (4.5mm) drill bit.

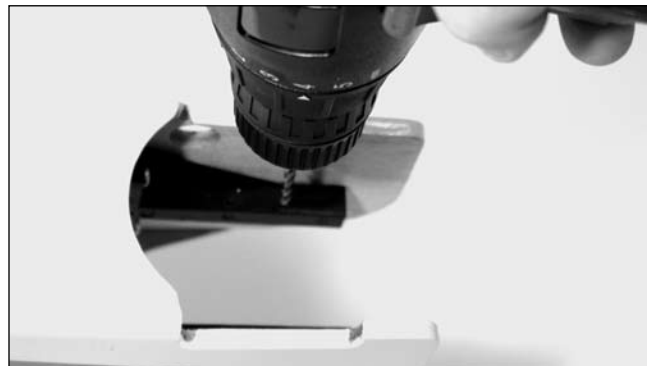

Hint: Use a drill press for the best results. This makes holes perfectly perpendicular (square) to the mount.

#### Step 5

Attach the engine using four 4mm x 25mm socket head screws, four 4mm washers and four 4mm lock nuts.

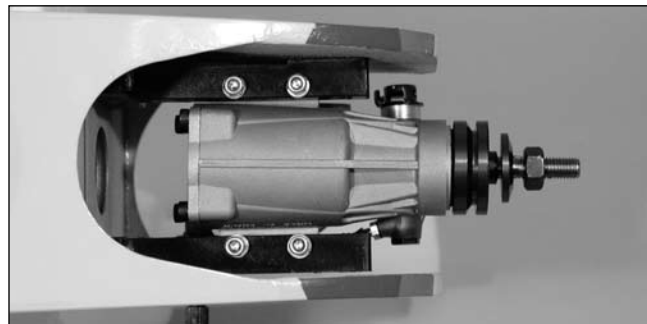

## Section 9: Throttle Pushrod Installation

### Required Parts

- Fuselage assembly
- Clevis
- Clevis retainer
- 10 1/8-inch (260mm) outer pushrod tube
- 14 5/8-inch (370mm) pushrod wire

### Required Tools and Adhesives

- Drill
- Medium CA
- Drill bit: 5/32-inch
- Sandpaper

#### Step 1

Determine the proper location for the throttle pushrod. Mark the location with a felt-tipped pen. Remove the engine and drill the firewall for the pushrod tube using a drill and 5/32-inch drill bit.



#### Step 2

Test fit the throttle pushrod tube through the firewall, through former 2, and into the fuselage. Once satisfied with the fit, roughen the tube using sandpaper. Slide the tube back into position and use medium CA to glue it to the firewall and former 2. Allow 1/4-inch of the pushrod to extend forward of the firewall.



# Section 9: Throttle Pushrod Installation (continued)

## Step 3

Slide a clevis retainer onto a nylon clevis. Thread a clevis onto a 14 5/8-inch (370mm) wire, a minimum of 10 turns.

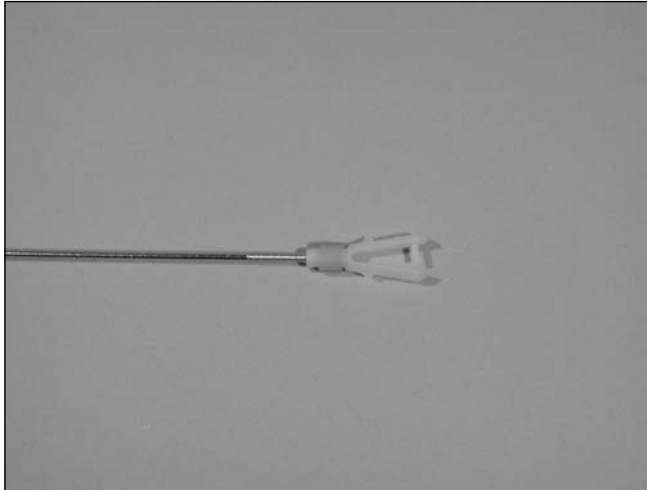

## Step 4

Attach the clevis to the throttle arm on the carburetor. Slide the pushrod wire into the pushrod tube and reinstall the engine. Bend the pushrod if necessary so it moves freely.

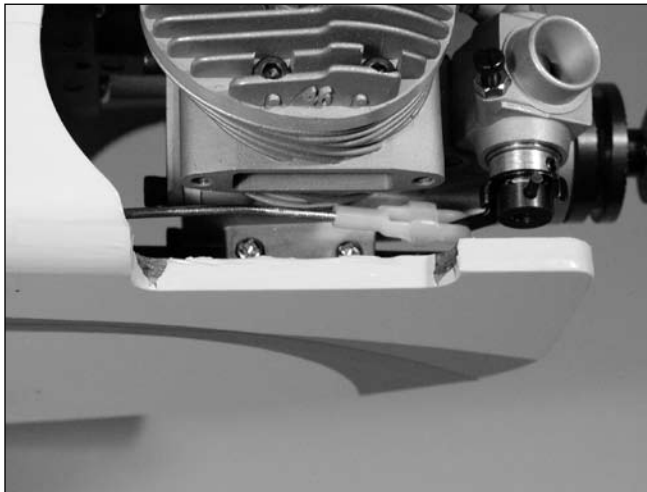

# Section 10: Fuel Tank Installation

## Required Parts

- Fuselage assembly
- Fuel tank assembly
- Fuel tubing (blue)

## Required Tools and Adhesives

- Foam: 1/2-inch

## Step 1

Glue a piece of 1/2-inch foam to the sides of the fuel tank compartment. Glue two pieces of 1/2-inch foam to the upper inside of the fuel tank compartment so there will be 1-inch of foam between the upper inside of the fuselage and the fuel tank.



## Step 2

Connect the two pieces of fuel tubing to the fuel tank's pickup and vent tubes. Note the vent and fuel line.

## Step 3

Install the fuel tank into the fuselage. Make any necessary supports to keep the tank from moving during flight.



Hint: Make sure the rear support brace will not interfere with the installation of the wing.

## Step 4

Attach the muffler to the engine. Make the proper connections to the engine using the engine manufacturer's instructions.

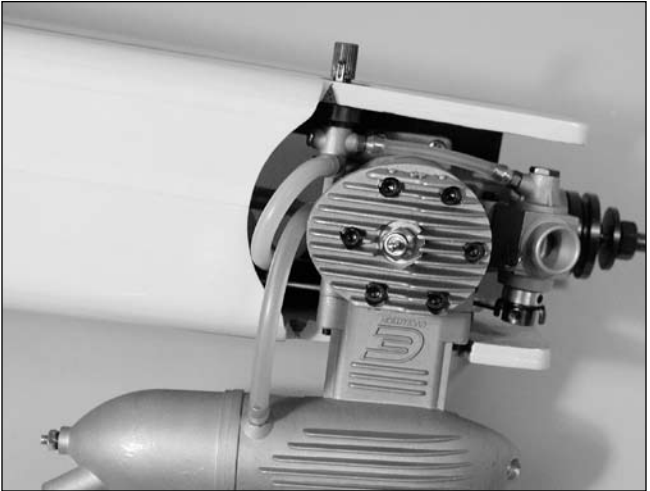

# Section 11: Landing Gear Installation

## Required Parts

- Fuselage assembly
- 4mm x 25mm axle with nut (2)
- 4mm wheel collar (2)
- 4mm x 20mm screw (4)
- 2 3/4-inch wheel (2)
- 1-inch wheel
- Landing gear
- Grub screw (2)

## Required Tools and Adhesives

- Drill
- Phillips screwdriver (large)
- Drill bits: 1/16-inch, 1/8-inch, 5/32-inch
- Hex wrench (included in kit)

### Step 1

Locate the main landing gear and four 4mm x 20mm screws. Attach the main landing gear using the screws. The angle on the gear should be toward the rear of the plane.

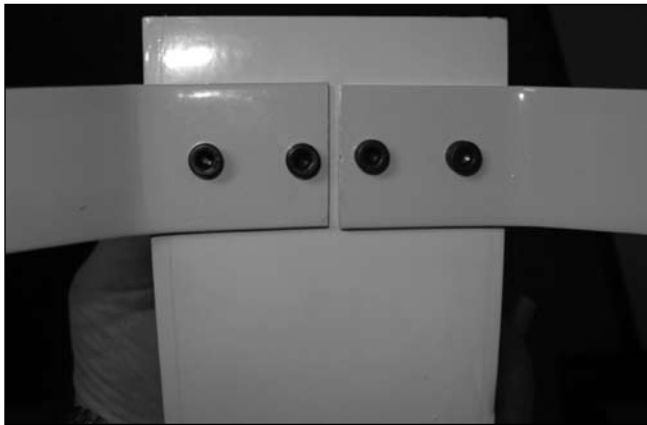

### Step 2

Attach the axle to each landing gear leg with the included two nuts and washers. Use threadlock when assembling the axle.

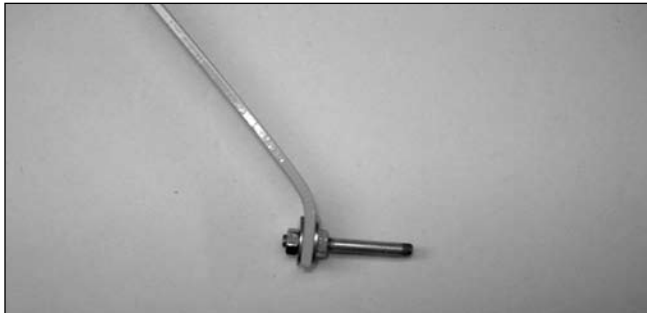

### Step 3

Attach the wheel to the axle using a wheel collar and grub screw.



Hint: File a flat area where the screw contacts the axle, to help prevent the screw from loosening during flight.



### Step 4

Repeat Steps 2 and 3 for the remaining wheel.

# Section 12: Radio Installation

## Required Parts

- Fuselage assembly
- Servo with hardware (5)
- Wing assembly

## Required Tools and Adhesives

- Drill
- Phillips screwdriver (small)
- Drill bit: 1/16-inch
- Servo extension – 12-inch (2)

### Step 1

Install the recommended servo hardware (grommets and eye-lets) supplied with your radio system onto five servos (elevator, rudder, throttle, and aileron (2)).

### Step 2

Temporarily install the rudder servo.

### Step 3

Mark the locations for the servo screws using a felt-tipped pen.



### Step 4

Remove the servo and drill the holes for the servo mounting screws using a 1/16-inch drill bit.



Hint: Place a drop of thin CA onto each screw hole to harden the wood around the hole. Allow the CA to fully cure before installing the servos.

### Step 5

Attach a 12-inch servo extension onto the rudder servo. Use your favorite method to secure the extension to prevent it from coming loose during flight. Secure the rudder servo using the screws provided with the servo.



### Step 6

Repeat Steps 1 through 5 for the elevator servo.

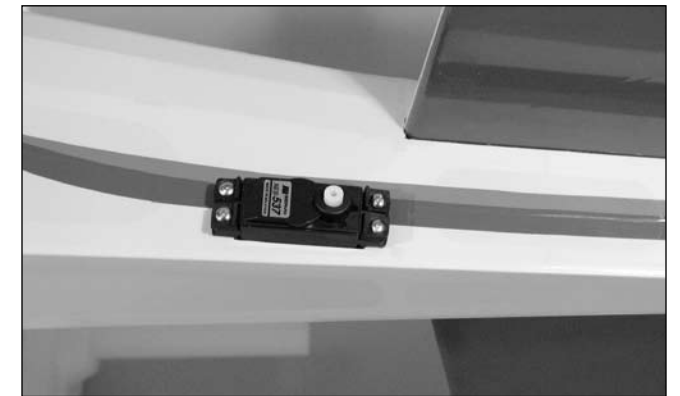

### Step 7

Temporarily install the aileron servo and mark the locations for the servo screws using a felt-tipped pen.

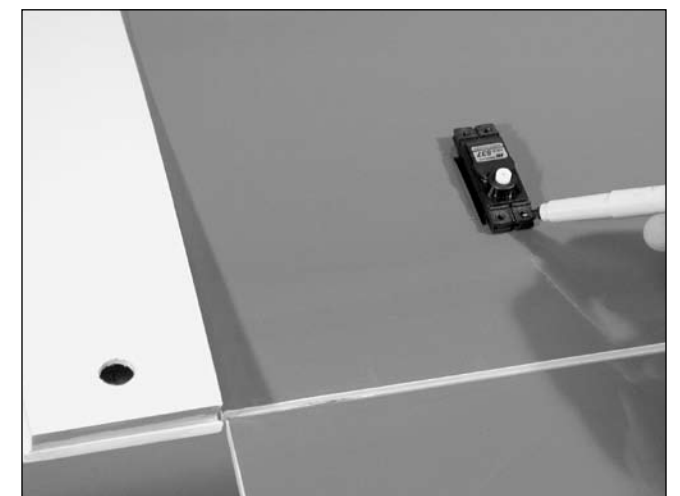

## Section 12: Radio Installation (continued)

### Step 8

Remove the servos and drill the holes for the servo mounting screws using a 1/16-inch drill bit.

### Step 9

Use a piece of string with a small weight (such as a wheel collar) attached as a device to pull the servo lead through the wing. Lower the weight through the servo opening, allowing it to pass through the ribs and out the hole in the center of the wing.

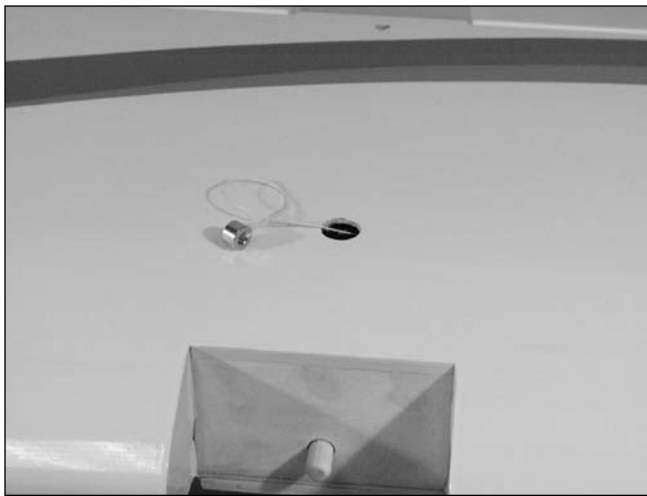

### Step 10

Tie the string onto the servo extension. Gently pull the extension through the wing using the string. Untie the string when the servo lead has been pulled through. Use tape to secure the servo lead to the wing to prevent it from falling back into the wing panel. Secure the aileron servo using the hardware provided with the servo.

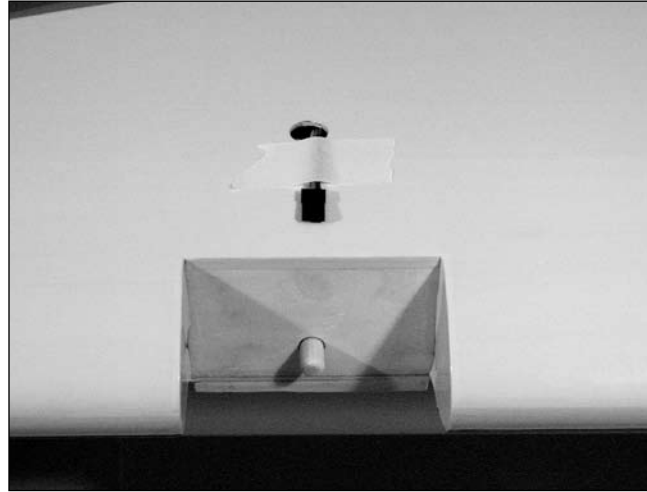

### Step 11

Repeat Steps 7 through 10 for the other aileron servo.

### Step 12

Secure the throttle servo using the screws supplied with the servo.

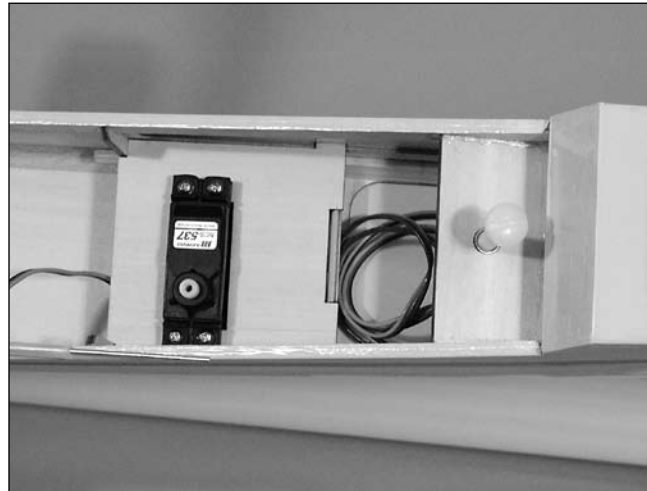

## Section 12: Radio Installation (continued)

### Step 13

Wrap the receiver and receiver battery in protective foam to prevent damage that may be caused by engine vibration.

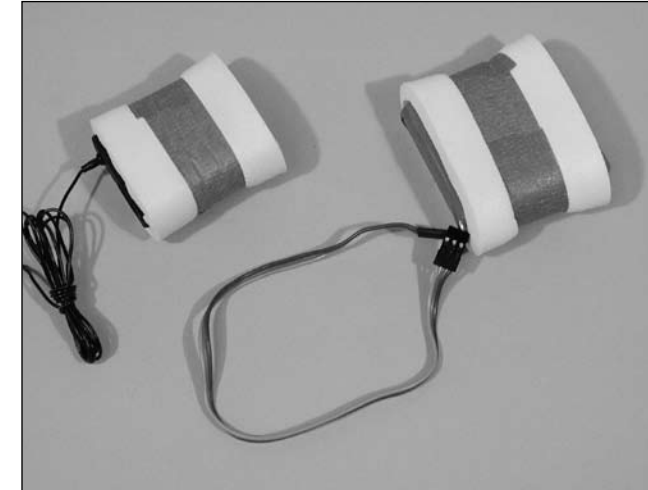

### Step 14

Temporarily mount the receiver and battery into the fuselage. It may be necessary to relocate the battery forward or aft to balance the model as described in the section "Control Throws and Center of Gravity." Plug in any servo leads or extensions at this time and connect any extensions necessary for the aileron servos.



### Step 15

Route the antenna out through the tube in the fuselage.

### Step 16

Mount the radio switch in the side of the fuselage opposite the throttle linkage.

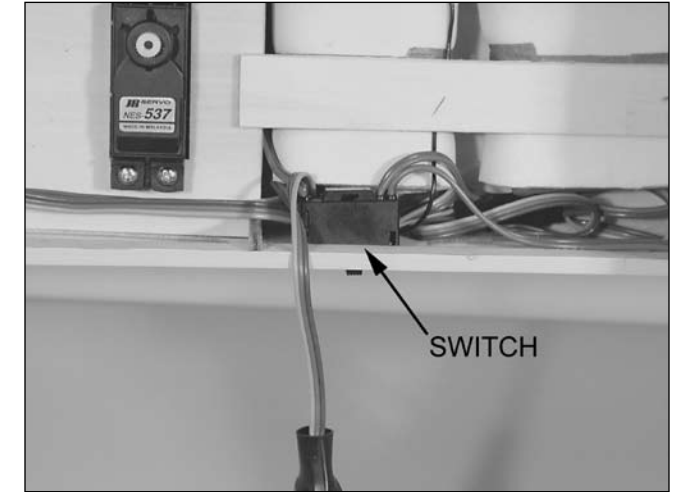

# Section 13: Linkage Installation

## Required Parts

- Fuselage assembly
- Wing assembly
- 4 3/8-inch pushrod wire (2)
- Nylon clevis (4)
- 10 5/8-inch pushrod wire (2)
- Clevis retainer (4)
- Nylon wire keeper (5)
- Clevis retainer (4)
- Nylon control horn (4)
- 1.5mm x 15mm screw (12)

## Required Tools and Adhesives

- Drill bits: 1/16-inch, 3/32-inch
- Drill
- Phillips screwdriver (small)

### □ □ Step 1

Slide a clevis retainer onto a nylon clevis. Thread a clevis onto a 10 5/8-inch wire, a minimum of 10 turns.

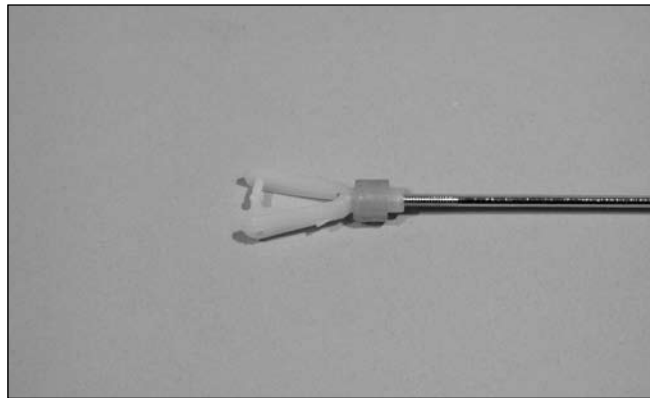

### □ □ Step 2

Remove the backplate from a control horn using side cutters or a sharp hobby knife.

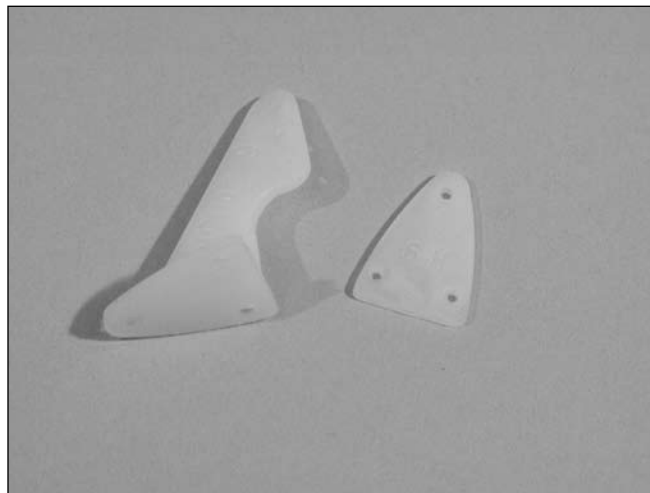

### □ □ Step 3

Position the control horn on the elevator so the horn aligns with the hinge line of the elevator. Mark the position for the mounting holes using a felt-tipped pen.

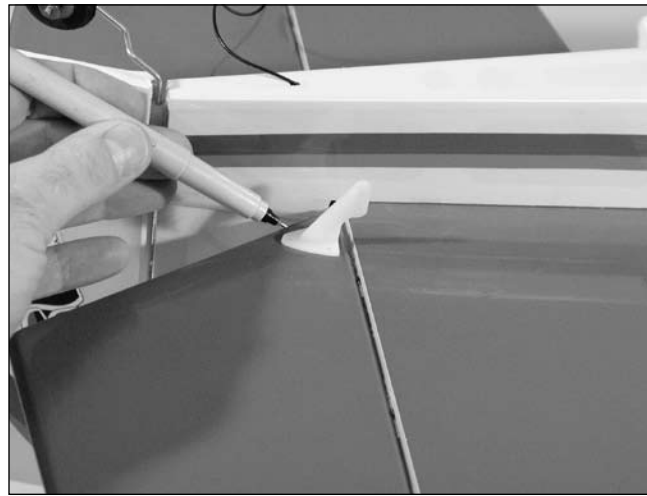

### □ □ Step 4

Drill three 3/32-inch holes through the elevator at the locations marked in the previous step.

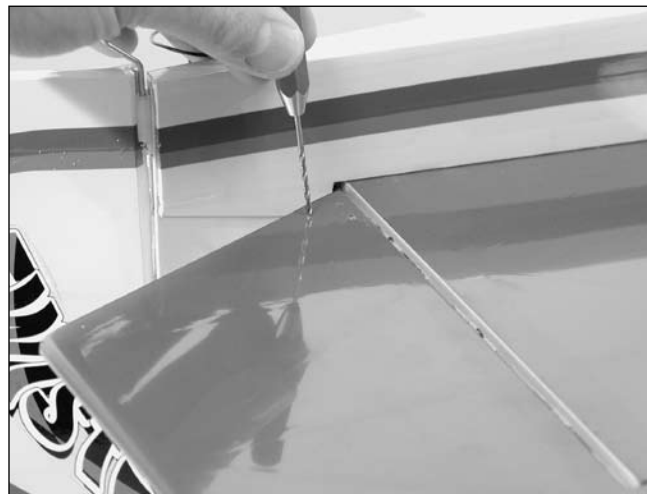

# Section 13: Linkage Installation (continued)

### □ □ Step 5

Place 2–3 drops of thin CA into the hole to harden the wood. Repeat this for each of the three holes.



### □ □ Step 6

Attach the control horn using three 1.5mm x 15mm screws and the control backplate.



### □ □ Step 7

Center the elevator servo electronically using the radio system. Install a servo arm onto the elevator servo. Attach the pushrod with clevis to the control horn. Physically place the elevator control surface in neutral. Mark the pushrod where it crosses the holes in the servo arm.



### □ □ Step 8

Bend the wire 90-degrees at the mark made in the previous step.



### □ □ Step 9

Cut the wire 3/8-inch (10mm) above the bend.

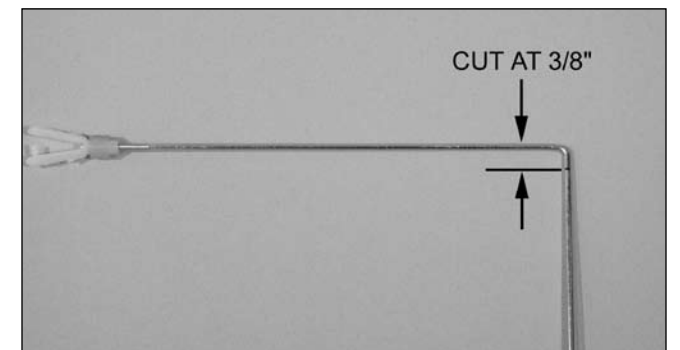

## Section 13: Linkage Installation (continued)

### Step 10

Slide the wire through the hole one in from the end of the elevator servo arm. Secure the wire using a nylon wire keeper.



### Step 11

Repeat Steps 1 through 10 for the rudder linkage.

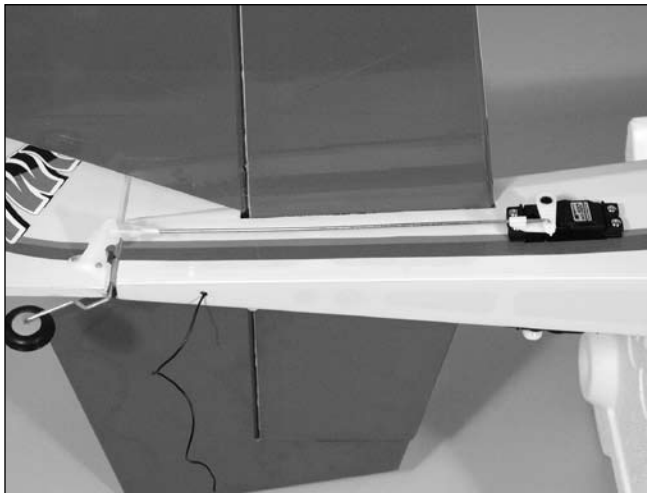

### Step 12

Slide a clevis retainer onto a nylon clevis. Thread a clevis onto a 4 3/8-inch wire a minimum of 10 turns.

### Step 13

Remove the backplate from a control horn using side cutters or a sharp hobby knife.

### Step 14

Position the control horn on the aileron so the horn aligns with the hinge line of the aileron. Mark the position for the mounting holes using a felt-tipped pen.

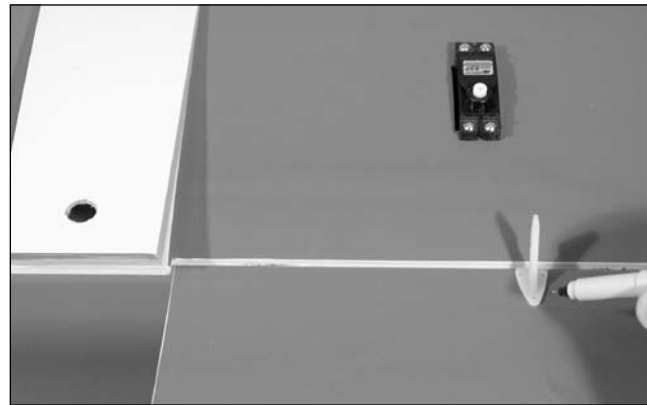

### Step 15

Drill three 3/32-inch holes at the locations marked in the previous step.

### Step 16

Place 2–3 drops of thin CA into the hole to harden the wood. Repeat this for each of the three holes.

### Step 17

Attach the control horn using three 1.5mm x 15mm screws and the control backplate.

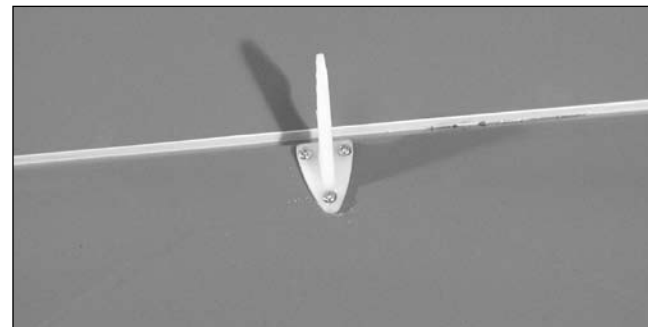

## Section 13: Linkage Installation (continued)

### Step 18

Center the aileron servo electronically using the radio system. Install a servo arm onto the aileron servo. Attach the pushrod with clevis to the control horn. Physically place the aileron control surface in neutral. Mark the pushrod where it crosses the holes in the servo arm.

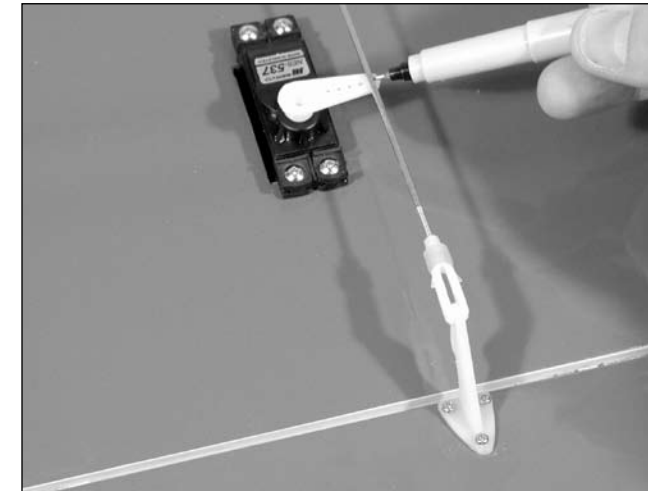

### Step 19

Bend the wire 90-degrees at the mark made in the previous step. Cut the wire 3/8-inch (10mm) above the bend.

### Step 20

Slide the wire through the outer hole in the aileron servo arm. Secure the wire using a nylon wire keeper.

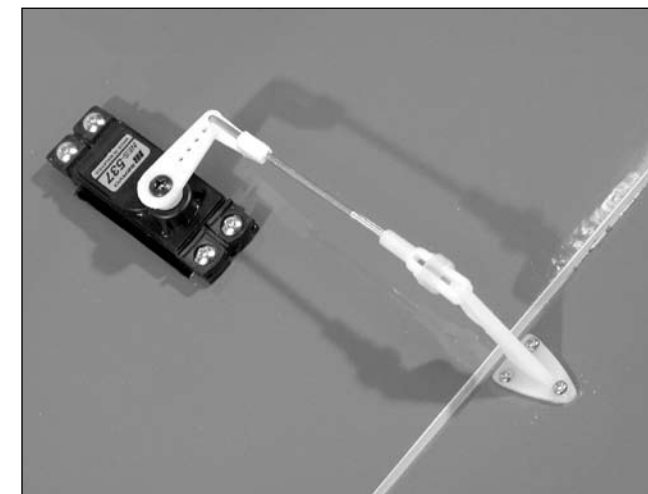

### Step 21

Repeat Steps 12 through 20 for the other aileron servo.

### Step 22

Center the throttle stick and trim with both the receiver and transmitter on. Install the throttle servo arm in the neutral position.

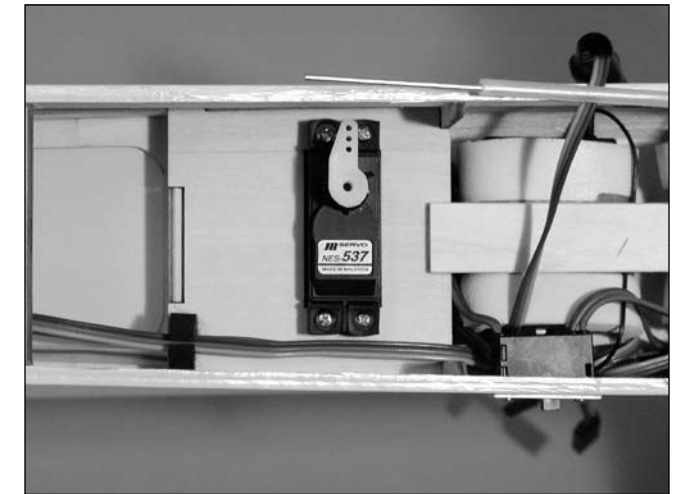

### Step 23

Move the servo to the throttle closed position using the radio system. Manually move the throttle arm to the closed position. Mark the location where the pushrod crosses the servo arm using a felt-tipped pen.

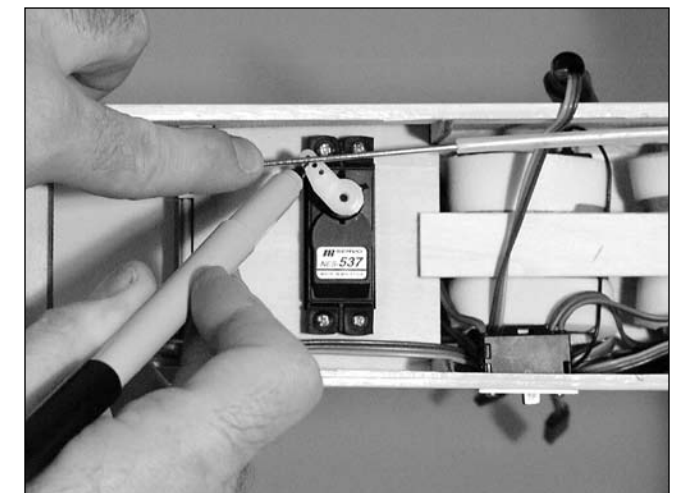

## Section 13: Linkage Installation (continued)

### Step 24

Make a 90-degree bend at the mark made in the last step. Temporarily connect the pushrod to the throttle arm. Check the movement of the throttle to verify there is no binding at either low or high throttle. If there is, make the necessary adjustment to eliminate any binding.



### Step 25

Secure the throttle pushrod to the servo arm using a nylon wire keeper. Install the throttle servo arm screw when complete.



## Section 14: Canopy Installation

### Required Parts

- Fuselage assembly
- Canopy

### Required Tools and Adhesives

- Canopy glue (PAAPT56)
- Sandpaper (medium grit)

### Step 1

Install a pilot of your choosing. Use epoxy to secure the pilot.

### Step 2

Position the canopy onto the fuselage. Trace around the canopy and onto the fuselage using a felt-tipped pen.



### Step 3

Lightly sand the inside edge of the canopy and slightly inside the line drawn on the hatch using medium sandpaper.

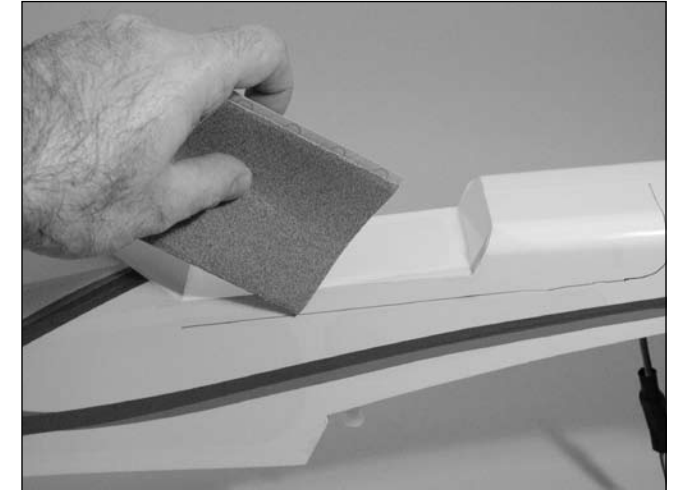

### Step 4

Apply a bead of Formula 560 Canopy Glue (PAAPT56) around the inside edge of the canopy. Position the canopy onto the hatch. Use tape to hold it secure until the glue fully cures.

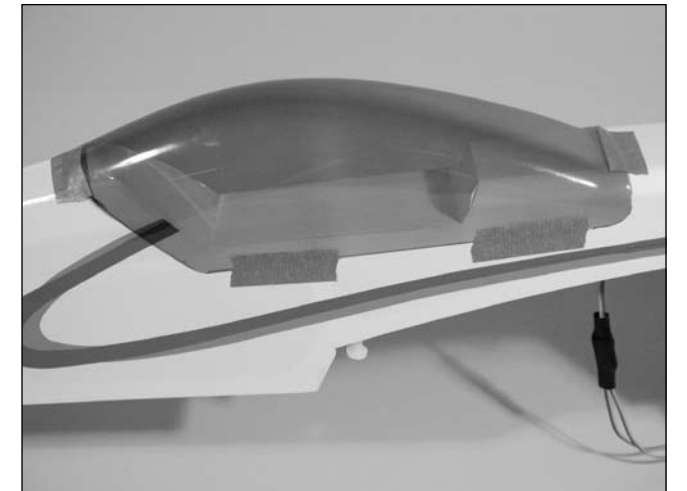

# Adjusting the Engine

## ☐ Step 1

Completely read the instructions included with your engine and follow the recommended break-in procedure.

## ☐ Step 2

At the field, adjust the engine to a slightly rich setting at full throttle and adjust the idle and low-speed needle so that a consistent idle is achieved.

# Control Throws

The amount of control throw should be adjusted as closely as possible using mechanical means, rather than making large changes electronically at the radio. By moving the position of the clevis at the control horn toward the outermost hole, you will decrease the amount of control throw of the control surface. Moving it toward the control surface will increase the amount of throw. Moving the pushrod wire at the servo arm will have the opposite effect. Moving it closer to center will decrease throw, and away from center will increase throw. Work with a combination of the two to achieve the closest or exact control throws listed.

## ☐ Step 3

Before you fly, be sure your engine idles reliably, transitions and runs at all throttle settings. Only when this is achieved should any plane be considered ready for flight.

	Low Rate	High Rate
Aileron:	1-inch (15°) up 1-inch (15°) down	1 5/8-inch (23°) up 1 5/8-inch (23°) down
Elevator:	1-inch (14°) up 1-inch (14°) down	2-inch (25°) up 2-inch (25°) down
Rudder:	1 3/4-inch (18°) left 1 3/4-inch (18°) right	2-inch (22°) left 2-inch (22°) right

Note: Control throws are measured at the widest part of the elevator, rudder, and aileron unless noted otherwise.

Use the following throws for 3D aerobatics:

Aileron:	2 1/2-inch (35°) up	2 1/2-inch (35°) down
Elevator:	2 3/4-inch (35°) up	2 3/4-inch (35°) down
Rudder:	2 1/2-inch (28°) right	2 1/2-inch (28°) left

# Recommended CG

An important part of preparing the aircraft for flight is properly balancing the model. This is especially important when various engines are mounted.

## **Caution: Do not inadvertently skip this step!**

The recommended Center of Gravity (CG) range for the Twist is 4–5-inches behind the leading edge of the wing against the fuselage. It is suggested to start at the forward end of the range until comfortable with the flight characteristics of your aircraft. If necessary, move the battery pack or add weight to either the nose or the tail until the correct balance is achieved. Stick-on weights are available at your local hobby shop and work well for this purpose.

# Preflight

Charge both the transmitter and receiver pack for your airplane. Use the recommended charger supplied with your particular radio system, following the instructions provided with the radio. In most cases the radio should be charged the night before flying.

Check the radio installation and make sure all the control surfaces are moving correctly (i.e. the correct direction and with the recommended throws). Test-run the engine and make sure it transitions smoothly from idle to full throttle and back. Also ensure the engine is tuned according to the manufacturer's instructions, and it will run consistently and constantly at full throttle when adjusted.

# Range Testing the Radio

Check all the control horns, servo horns and clevises to make sure they are secure and in good condition. Replace any items that would be considered questionable. Failure of any of these components in flight would mean the loss of your aircraft.

Before each flying session, range-check your radio. This is accomplished by turning on your transmitter with the antenna collapsed. Turn on the radio in your airplane. With your airplane on the ground, you should be able to walk 30 paces away from your airplane and still have complete control of all functions. If not, don't attempt to fly! Have your radio equipment checked out by the manufacturer.



# 2010 Official Academy of Model Aeronautics Safety Code

## GENERAL

1. A model aircraft shall be defined as a non-humancarrying device capable of sustained flight in the atmosphere. It shall not exceed limitations established in this code and is intended to be used exclusively for recreational or competition activity.
2. The maximum takeoff weight of a model aircraft, including fuel, is 55 pounds, except for those flown under the AMA Experimental Aircraft Rules.
3. I will abide by this Safety Code and all rules established for the flying site I use. I will not willfully fly my model aircraft in a reckless and/or dangerous manner.
4. I will not fly my model aircraft in sanctioned events, air shows, or model demonstrations until it has been proven airworthy.
5. I will not fly my model aircraft higher than approximately 400 feet above ground level, when within three (3) miles of an airport without notifying the airport operator. I will yield the right-of-way and avoid flying in the proximity of full-scale aircraft, utilizing a spotter when appropriate.
6. I will not fly my model aircraft unless it is identified with my name and address, or AMA number, inside or affixed to the outside of the model aircraft. This does not apply to model aircraft flown indoors.
7. I will not operate model aircraft with metal-blade propellers or with gaseous boosts (other than air), nor will I operate model aircraft with fuels containing tetranitromethane or hydrazine.
8. I will not operate model aircraft carrying pyrotechnic devices which explode burn, or propel a projectile of any kind. Exceptions include Free Flight fuses or devices that burn producing smoke and are securely attached to the model aircraft during flight. Rocket motors up to a G-series size may be used, provided they remain firmly attached to the model aircraft during flight. Model rockets may be flown in accordance with the National Model Rocketry Safety Code; however, they may not be launched from model aircraft. Officially designated AMA Air Show Teams (AST) are authorized to use devices and practices as defined within the Air Show Advisory Committee Document.
9. I will not operate my model aircraft while under the influence of alcohol or within eight (8) hours of having consumed alcohol.
10. I will not operate my model aircraft while using any drug which could adversely affect my ability to safely control my model aircraft.
11. Children under six (6) years old are only allowed on a flightline or in a flight area as a pilot or while under flight instruction.
12. When and where required by rule, helmets must be properly worn and fastened. They must be OSHA, DOT, ANSI, SNELL or NOCSAE approved or comply with comparable standards.

## RADIO CONTROL

1. All model flying shall be conducted in a manner to avoid over flight of unprotected people.
2. I will have completed a successful radio equipment ground-range check before the first flight of a new or repaired model aircraft.
3. I will not fly my model aircraft in the presence of spectators until I become a proficient flier, unless I am assisted by an experienced pilot.
4. At all flying sites a line must be established, in front of which all flying takes place. Only personnel associated with flying the model aircraft are allowed at or in front of the line. In the case of airshows demonstrations straight line must be established. An area away from the line must be maintained for spectators. Intentional flying behind the line is prohibited.
5. I will operate my model aircraft using only radio control frequencies currently allowed by the Federal Communications Commission (FCC). Only individuals properly licensed by the FCC are authorized to operate equipment on Amateur Band frequencies.

# Warranty Information

## Warranty Period

Exclusive Warranty- Horizon Hobby, Inc., (Horizon) warrants that the Products purchased (the “Product”) will be free from defects in materials and workmanship at the date of purchase by the Purchaser.

## Limited Warranty

(a) This warranty is limited to the original Purchaser (“Purchaser”) and is not transferable. REPAIR OR REPLACEMENT AS PROVIDED UNDER THIS WARRANTY IS THE EXCLUSIVE REMEDY OF THE PURCHASER. This warranty covers only those Products purchased from an authorized Horizon dealer. Third party transactions are not covered by this warranty. Proof of purchase is required for warranty claims. Further, Horizon reserves the right to change or modify this warranty without notice and disclaims all other warranties, express or implied.

(b) Limitations- HORIZON MAKES NO WARRANTY OR REPRESENTATION, EXPRESS OR IMPLIED, ABOUT NON-INFRINGEMENT, MERCHANTABILITY OR FITNESS FOR A PARTICULAR PURPOSE OF THE PRODUCT. THE PURCHASER ACKNOWLEDGES THAT THEY ALONE HAVE DETERMINED THAT THE PRODUCT WILL SUITABLY MEET THE REQUIREMENTS OF THE PURCHASER’S INTENDED USE.

(c) Purchaser Remedy- Horizon’s sole obligation hereunder shall be that Horizon will, at its option, (i) repair or (ii) replace, any Product determined by Horizon to be defective. In the event of a defect, these are the Purchaser’s exclusive remedies. Horizon reserves the right to inspect any and all equipment involved in a warranty claim. Repair or replacement decisions are at the sole discretion of Horizon. This warranty does not cover cosmetic damage or damage due to acts of God, accident, misuse, abuse, negligence, commercial use, or modification of or to any part of the Product. This warranty does not cover damage due to improper installation, operation, maintenance, or attempted repair by anyone other than Horizon. Return of any goods by Purchaser must be approved in writing by Horizon before shipment.

## Damage Limits

HORIZON SHALL NOT BE LIABLE FOR SPECIAL, INDIRECT OR CONSEQUENTIAL DAMAGES, LOSS OF PROFITS OR PRODUCTION OR COMMERCIAL LOSS IN ANY WAY CONNECTED WITH THE PRODUCT, WHETHER SUCH CLAIM IS BASED IN CONTRACT, WARRANTY, NEGLIGENCE, OR STRICT LIABILITY. Further, in no event shall the liability of Horizon exceed the individual price of the Product on which liability is asserted. As Horizon has no control over use, setup, final assembly, modification or misuse, no liability shall be assumed nor accepted for any resulting damage or injury. By the act of use, setup or assembly, the user accepts all resulting liability.

If you as the Purchaser or user are not prepared to accept the liability associated with the use of this Product, you are advised to return this Product immediately in new and unused condition to the place of purchase.

Law: These Terms are governed by Illinois law (without regard to conflict of law principals).

## Safety Precautions

This is a sophisticated hobby Product and not a toy. It must be operated with caution and common sense and requires some basic mechanical ability. Failure to operate this Product in a safe and responsible manner could result in injury or damage to the Product or other property. This Product is not intended for use by children without direct adult supervision. The Product manual contains instructions for safety, operation and maintenance. It is essential to read and follow all the instructions and warnings in the manual, prior to assembly, setup or use, in order to operate correctly and avoid damage or injury.

## Questions, Assistance, and Repairs

Your local hobby store and/or place of purchase cannot provide warranty support or repair. Once assembly, setup or use of the Product has been started, you must contact Horizon directly. This will enable Horizon to better answer your questions and service you in the event that you may need any assistance. For questions or assistance, please direct your email to [productsupport@horizonhobby.com](mailto:productsupport@horizonhobby.com), or call 877.504.0233 toll free to speak to a Product Support representative.

## Inspection or Repairs

If this Product needs to be inspected or repaired, please call for a Return Merchandise Authorization (RMA). Pack the Product securely using a shipping carton. Please note that original boxes may be included, but are not designed to withstand the rigors of shipping without additional protection. Ship via a carrier that provides tracking and insurance for lost or damaged parcels, as Horizon is not responsible for merchandise until it arrives and is accepted at our facility. A Service Repair Request is available at [www.horizonhobby.com](http://www.horizonhobby.com) on the "Support" tab. If you do not have internet access, please include a letter with your complete name, street address, email address and phone number where you can be reached during business days, your RMA number, a list of the included items, method of payment for any non-warranty expenses and a brief summary of the problem. Your original sales receipt must also be included for warranty consideration. Be sure your name, address, and RMA number are clearly written on the outside of the shipping carton.

## Warranty Inspection and Repairs

To receive warranty service, you must include your original sales receipt verifying the proof-of-purchase date. Provided warranty conditions have been met, your Product will be repaired or replaced free of charge. Repair or replacement decisions are at the sole discretion of Horizon Hobby.

## Non-Warranty Repairs

Should your repair not be covered by warranty the repair will be completed and payment will be required without notification or estimate of the expense unless the expense exceeds 50% of the retail purchase cost. By submitting the item for repair you are agreeing to payment of the repair without notification. Repair estimates are available upon request. You must include this request with your repair. Non-warranty repair estimates will be billed a minimum of ½ hour of labor. In addition you will be billed for return freight. Please advise us of your preferred method of payment. Horizon accepts money orders and cashiers checks, as well as Visa, MasterCard, American Express, and Discover cards. If you choose to pay by credit card, please include your credit card number and expiration date. Any repair left unpaid or unclaimed after 90 days will be considered abandoned and will be disposed of accordingly. Please note: non-warranty repair is only available on electronics and model engines.

## United States

Electronics and engines requiring inspection or repair should be shipped to the following address:

Horizon Service Center  
4105 Fieldstone Road  
Champaign, Illinois 61822  
USA

All other Products requiring warranty inspection or repair should be shipped to the following address:

Horizon Product Support  
4105 Fieldstone Road  
Champaign, Illinois 61822  
USA

Please call 877-504-0233 or e-mail us at [productsupport@horizonhobby.com](mailto:productsupport@horizonhobby.com) with any questions or concerns regarding this product or warranty.

## United Kingdom

Electronics and engines requiring inspection or repair should be shipped to the following address:

Horizon Hobby UK  
Units 1-4 Ployters Rd  
Staple Tye  
Harlow, Essex  
CM18 7NS  
United Kingdom

Please call +44 (0) 1279 641 097 or e-mail us at [sales@horizonhobby.co.uk](mailto:sales@horizonhobby.co.uk) with any questions or concerns regarding this product or warranty.

## Germany

Electronics and engines requiring inspection or repair should be shipped to the following address:

Horizon Technischer Service  
Hamburger Strasse 10  
25335 Elmshorn  
Germany

Please call +49 4121 46199 66 or e-mail us at [service@horizonhobby.de](mailto:service@horizonhobby.de) with any questions or concerns regarding this product or warranty.

## Instructions for Disposal of WEEE by Users in the European Union

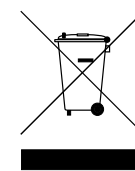

This product must not be disposed of with other waste. Instead, it is the user's responsibility to dispose of their waste equipment by handing it over to a designated collection point for the recycling of waste electrical and electronic equipment. The separate collection and recycling of your waste equipment at the time of disposal will help to conserve natural resources and ensure that it is recycled in a manner that protects human health and the environment. For more information about where you can drop off your waste equipment for recycling, please contact your local city office, your household waste disposal service or where you purchased the product.