

HANGAR 9

Pulse XT 40 ARF

ASSEMBLY MANUAL



Specifications

Wingspan..... 60.7 in (1540.5mm)
Wing Area 667 sq in (43 sq dm)
Length..... 50 in (1270mm)

Weight..... Glow: 5.5–6.25 lb (2.5 kg–2.8 kg)
..... Electric w/o battery: 4.7–5lb (2.1–2.3 kg)

Table of Contents

UltraCote Covering Colors	3
Radio and Power Systems Requirements	3
Contents of Kit	3
Required Items for Electric Installation	4
Field Equipment Required	4
Optional Field Equipment	4
Required Tools and Adhesives	4
Limited Warranty & Limits of Liability	5
Safety Precautions	5
Questions, Assistance, and Repairs	5
Questions or Assistance	5
Inspection or Repairs	6
Warranty Inspection and Repairs	6
Non-Warranty Repairs	6
Warranty Information	7
Before Starting Assembly	7
Using the Manual	7
Section 1: Aileron Installation	8
Section 2: Hinging the Stabilizer	13
Section 3: Hinging the Rudder	15
Section 4: Landing Gear Installation	17
Section 5: Servo Installation	20
Section 6A: Tail Installation	23
Section 6B: Gluing the Tail (Optional)	25
Section 7A: Electric Motor Installation	26
Section 7B: Glow Engine Installation	29
Section 8: Final Assembly	32
Control Throws	34
Recommended Center of Gravity (CG)	35
Pre-Flight	35
Range Test Your Radio	35
Adjusting the Engine (Glow)	36
Maintaining Your Pulse XT ARF	36
Glossary of Terms	37
2006 Official AMA National Model Aircraft Safety Code	38

UltraCote® Covering Colors

- True Red HANU866
- Silver HANU881

- White HANU870

Contents of Kit

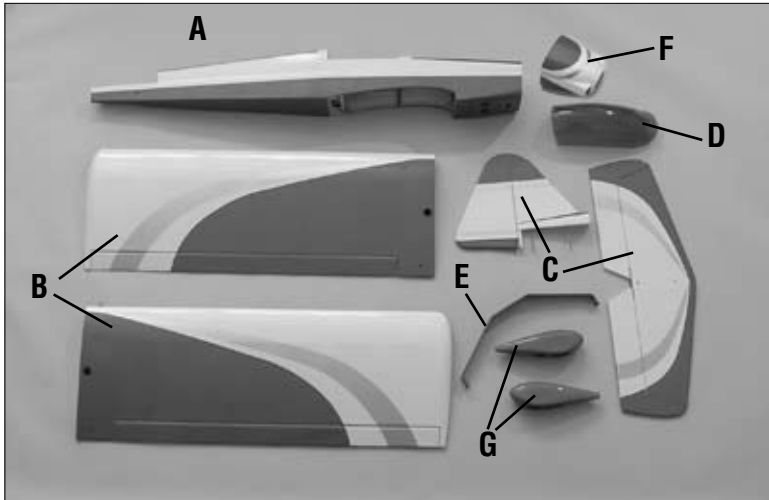

Replacement Parts

A.	Fuselage	HAN4101
B.	Wing w/o Aluminum Tube	HAN4102
C.	Tail Set	HAN4104
D.	Canopy	HAN4108
E.	Landing Gear	HAN4107
F.	Painted Cowling	HAN4105
G.	Painted Wheel Pants	HAN4106

Items not shown

Pushrod Set	HAN4109
Decal Set	HAN4112
Aluminum Wing Tube	HAN4103
Wing Bolt Set	HAN4110
EP Motor Mount	HAN4111

Radio and Power Systems Requirements

- 4-channel radio system (minimum) w/receiver
- 537 Standard Servo (JRPS537) (5) or equivalent (4 required when building the electric version)
- 9" Servo Lead Extension (JRPA097) (2)
- 6" Y-Harness (JSP98020)

Recommended JR® Systems

- XP9303
- XP6102
- XP662
- XF631
- XF421EX



Recommended Power Systems

- .40-.48 2-stroke
- .40-.82 4-stroke
- Power 46 Brushless Outrunner



Required Items for Electric Installation

- Female Deans connector w/wire
- Soldering iron
- Phoenix-60 Speed Control (CSEPHX60)
- Heat shrink tubing: 1/4" (6mm)
- 4200mAh 2S2P 7.4V Li-Po, 13GA (THP42002S2PPL) (2)
- Male Deans connector (3)
- Solder
- Electric Propeller, 13 x 6.5E (APC13065E)

Field Equipment Required

- Propeller
- Long Reach Glow Plug Wrench (HAN2510)
- 2-Cycle Sport Plug (HAN3001)
- 4-Cycle Super Plug (HAN3011)
- Fuel
- Metered Glow Driver w/Ni-Cd & Charger (HAN7101)
- 2-Cycle Super Plug (HAN3006)
- Manual Fuel Pump (HAN118)

Optional Field Equipment

- Fieldmate™ Pre-built Flight Box (HAN117)
- Blue Block After Run Oil (EVOX1000)
- 12V 7Ah Sealed Battery (HAN102)
- Cleaner & towels
- Power Panel (HAN106)
- PowerPro™ 12V Starter (HAN161)

Required Tools and Adhesives

Tools

- Adjustable wrench
- Drill bit: 1/16" (1.5mm), 5/64" (2mm), 9/64" (3.5mm), 5/32" (4mm)
- Hobby knife
- Phillips screwdriver (large)
- Ruler
- Square
- Drill
- Masking tape
- Phillips screwdriver (small)
- Sandpaper
- Straight edge

Adhesives

- 6-minute epoxy
- Thin CA (cyanoacrylate) glue
- Pacer Z-42 Threadlock
- 30-minute epoxy
- CA remover/debonder

Other Required Items

- Epoxy brushes
- Mixing sticks for epoxy
- Petroleum jelly
- Sandpaper
- T-pins
- Felt-tipped pen or pencil
- Paper towels
- Rubbing alcohol
- String

Limited Warranty & Limits of Liability

Pursuant to this Limited Warranty, Horizon Hobby, Inc. will, at its option, (i) repair or (ii) replace, any product determined by Horizon Hobby, Inc. to be defective. In the event of a defect, these are your exclusive remedies.

This warranty does not cover cosmetic damage or damage due to acts of God, accident, misuse, abuse, negligence, commercial use, or modification of or to any part of the product. This warranty does not cover damage due to improper installation, operation, maintenance, or attempted repair by anyone other than an authorized Horizon Hobby, Inc. service center. This warranty is limited to the original purchaser and is not transferable. In no case shall Horizon Hobby's liability exceed the original cost of the purchased product and will not cover consequential, incidental or collateral damage. Horizon Hobby, Inc. reserves the right to inspect any and all equipment involved in a warranty claim. Repair or replacement decisions are at the sole discretion of Horizon Hobby, Inc. Further, Horizon Hobby reserves the right to change or modify this warranty without notice.

REPAIR OR REPLACEMENT AS PROVIDED UNDER THIS WARRANTY IS THE EXCLUSIVE REMEDY OF THE CONSUMER. HORIZON HOBBY, INC. SHALL NOT BE LIABLE FOR ANY INCIDENTAL OR CONSEQUENTIAL DAMAGES.

As Horizon Hobby, Inc. has no control over use, setup, final assembly, modification or misuse, no liability shall be assumed nor accepted for any resulting damage or injury. By the act of use, setup or assembly, the user accepts all resulting liability.

If you as the purchaser or user are not prepared to accept the liability associated with the use of this product, you are advised to return this product immediately in new and unused condition to the place of purchase.

Safety Precautions

This is a sophisticated hobby product and not a toy. It must be operated with caution and common sense and requires some basic mechanical ability. Failure to operate this product in a safe and responsible manner could result in injury or damage to the product or other property. This product is not intended for use by children without direct adult supervision.

The product manual contains instructions for safety, operation and maintenance. It is essential to read and follow all the instructions and warnings in the manual, prior to assembly, setup or use, in order to operate correctly and avoid damage or injury.

Questions, Assistance, and Repairs

Your local hobby store and/or place of purchase cannot provide warranty support or repair. Once assembly, setup or use of the product has been started, you must contact Horizon Hobby, Inc. directly. This will enable Horizon to better answer your questions and service you in the event that you may need any assistance.

Questions or Assistance

For questions or assistance, please direct your email to productsupport@horizonhobby.com, or call 877.504.0233 toll free to speak to a service technician.

Inspection or Repairs

If your product needs to be inspected or repaired, please call for a Return Merchandise Authorization (RMA). Pack the product securely using a shipping carton. Please note that original boxes may be included, but are not designed to withstand the rigors of shipping without additional protection. Ship via a carrier that provides tracking and insurance for lost or damaged parcels, as Horizon Hobby, Inc. is not responsible for merchandise until it arrives and is accepted at our facility. Include your complete name, address, phone number where you can be reached during business days, RMA number, and a brief summary of the problem. Be sure your name, address, and RMA number are clearly written on the shipping carton.

Warranty Inspection and Repairs

To receive warranty service, you must include your original sales receipt verifying the proof-of-purchase date. Providing warranty conditions have been met, your product will be repaired or replaced free of charge. Repair or replacement decisions are at the sole discretion of Horizon Hobby. Horizon Hobby, Inc. guarantees this product to be free from defects in both material and workmanship at the date of purchase.

Non-Warranty Repairs

Should your repair not be covered by warranty and the expense exceeds 50% of the retail purchase cost, you will be provided with an estimate advising you of your options. You will be billed for any return freight for non-warranty repairs. Please advise us of your preferred method of payment. Horizon Hobby accepts money orders and cashiers checks, as well as Visa, MasterCard, American Express, and Discover cards. If you choose to pay by credit card, please include your credit card number and expiration date. Any repair left unpaid or unclaimed after 90 days will be considered abandoned and will be disposed of accordingly.

Electronics and engines requiring inspection or repair should be shipped to the following address (freight prepaid):

Horizon Service Center
4105 Fieldstone Road
Champaign, Illinois 61822

All other products requiring inspection or repair should be shipped to the following address (freight prepaid):

Horizon Product Support
4105 Fieldstone Road
Champaign, Illinois 61822

Warranty Information

Horizon Hobby, Inc. guarantees this kit to be free from defects in both material and workmanship at the date of purchase. This warranty does not cover any parts damage by use or modification. In no case shall Horizon Hobby's liability exceed the original cost of the purchased kit. Further, Horizon Hobby reserves the right to change or modify this warranty without notice. In that Horizon Hobby has no control over the final assembly or material used for the final assembly, no liability shall be assumed nor accepted for any damage resulting from the use by the user of the final user-assembled product. By the act of using the user-assembled product, the user accepts all resulting liability.

Once assembly of the model has been started, you must contact Horizon Hobby, Inc. directly regarding any warranty question that you have. Please do not contact your local hobby shop regarding warranty issues, even if that is where you purchased it. This will enable Horizon to better answer your questions and service you in the event that you may need any assistance. If the buyer is not prepared to accept the liability associated with the use of this product, the buyer is advised to return this kit immediately in new and unused condition to the place of purchase.

Horizon Hobby
4105 Fieldstone Road
Champaign, Illinois 61822
(217) 355-9511

Before Starting Assembly

Before beginning the assembly of the Pulse XT, remove each part from its bag for inspection. Closely inspect the fuselage, wing panels, rudder, and stabilizer for damage. If you find any damaged or missing parts, contact the place of purchase. If you find any wrinkles in the covering, use a heat gun or sealing iron to remove them. Use caution while working around areas where the colors overlap to prevent separating the colors.



HAN101 – Sealing Iron

**HAN141 – Sealing Iron
Sock**



HAN100 – Heat Gun

HAN150 – Covering Glove

Using the Manual

This manual is divided into sections to help make assembly easier to understand, and to provide breaks between each major section. In addition, check boxes have been placed next to each step to keep track of each step completed. Steps with a single box () are performed once, while steps with two boxes () indicate that the step will require repeating, such as for a right or left wing panel, two servos, etc. Remember to take your time and follow the directions.

Section 1: Aileron Installation

Required Parts

- Wing panel (right and left)
- Servo w/hardware (2)
- CA hinge (8)
- Servo extension, 6" (152mm)
- Aileron linkage, 4" (102mm) (2)
- Control horn w/backplate (2)
- 2mm x 16mm screw (4)
- 2mm x 12mm screw (2)
- Aileron (right and left)
- Clevis w/retainer (2)

Required Tools and Adhesives

- Thin CA
- Hobby knife
- T-pins
- Drill bit: 1/16" (1.5mm), 5/64" (2mm)
- Drill
- Felt-tipped pen
- Phillips screwdriver

□ □ Step 1

Locate four CA hinges. Place a T-pin in the center of each of the four hinges.

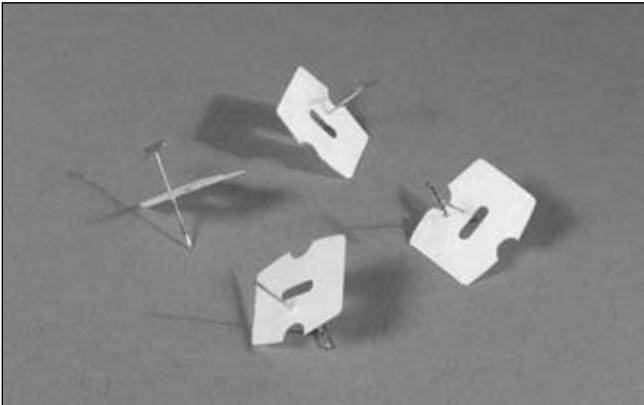

□ □ Step 2

Use a 1/16" (1.5mm) drill bit to drill a hole in the center of each hinge slot. Drill holes for both the wing and aileron.

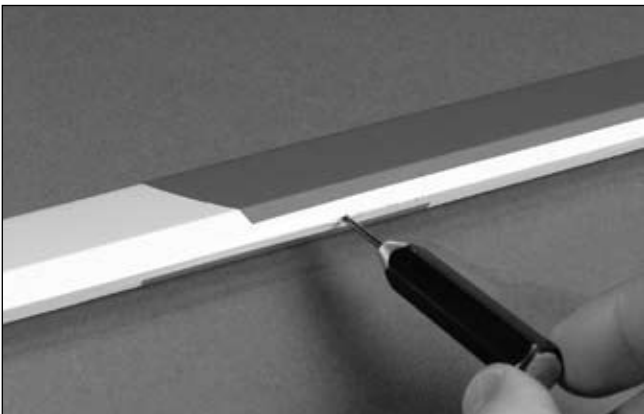

Note: The hole will allow the CA to penetrate the hinge farther into the surface, providing a better bond between the hinge and wood.

□ □ Step 3

Slide the hinges into the aileron. The T-pins will rest against the hinge line of the aileron.

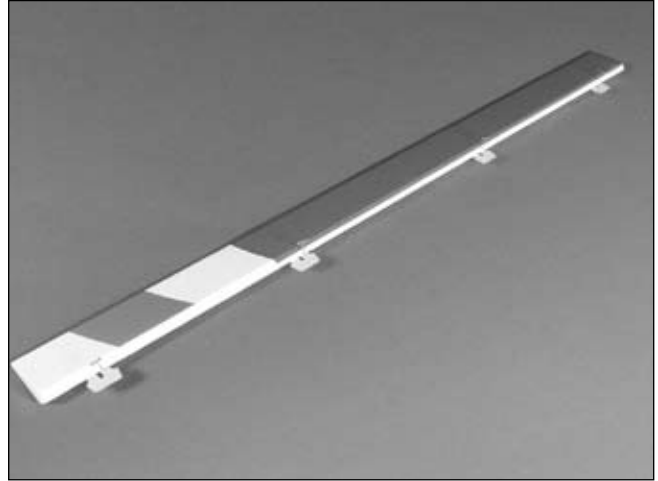

□ □ Step 4

Slide the aileron onto the wing. Press the aileron tightly against the wing, and then remove the T-pins from the hinges.

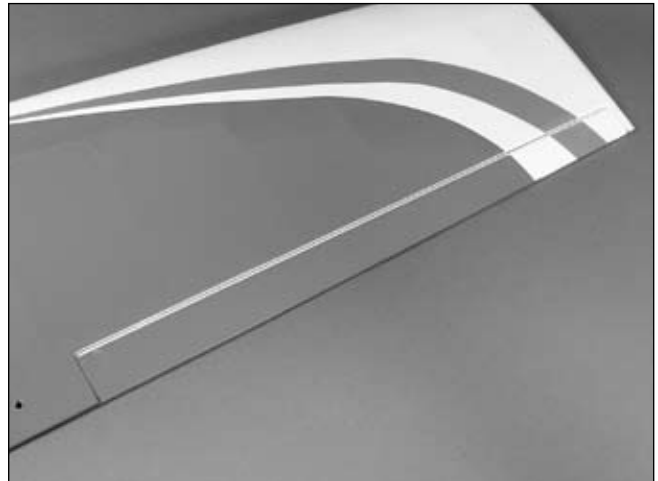

Section 1: Aileron Installation

□ □ Step 5

Position the aileron so it can move freely and not bind at the wing tip or wing root. Deflect the aileron without changing the hinge gap, and apply thin CA to each of the four hinges. Apply CA to both the top and bottom of the hinges.

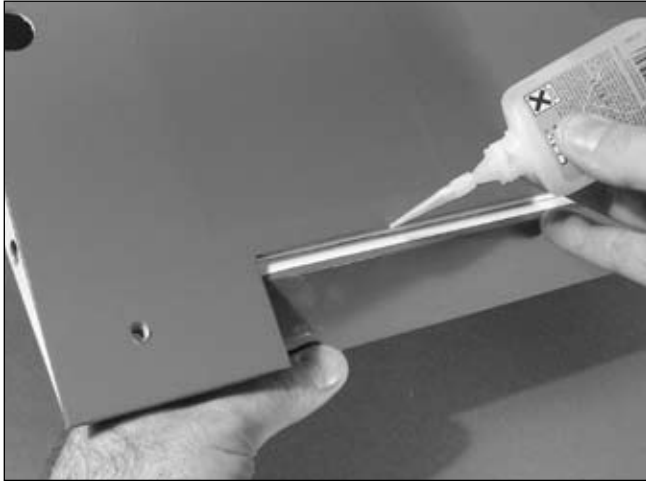

Note: Do not use CA accelerator on the hinges; the CA must be allowed to soak into the hinge.

□ □ Step 6

Once the CA has fully cured, gently pull on the aileron to make sure the hinges are secure. Avoid too much pressure which could cause damage to the wing and aileron.



□ □ Step 7

Flex the aileron up and down a number of times to break in the hinges.

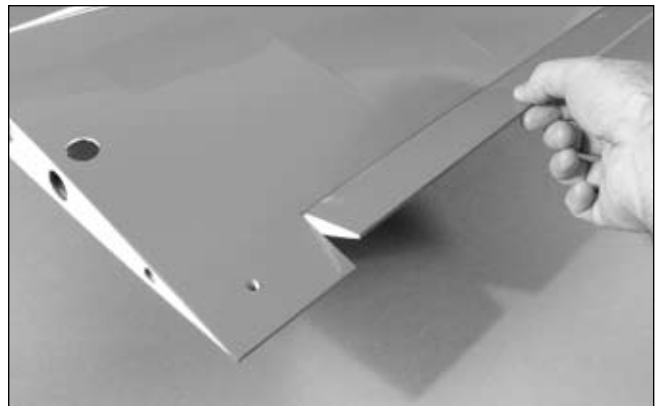
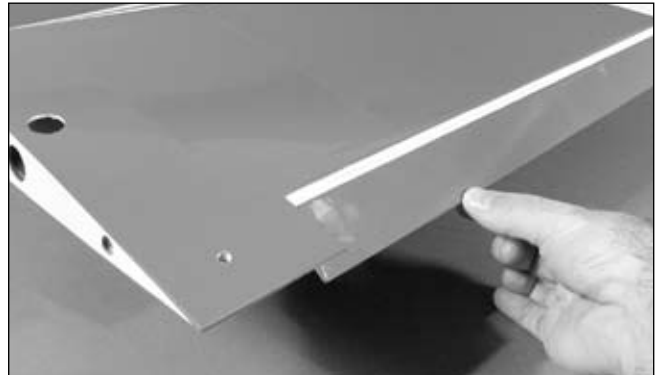

□ □ Step 8

Prepare an aileron servo by installing the grommets and brass eyelets provided with the servo. Secure a 6" (152mm) servo extension to the servo using a commercially available connector or with string or unwaxed dental floss.

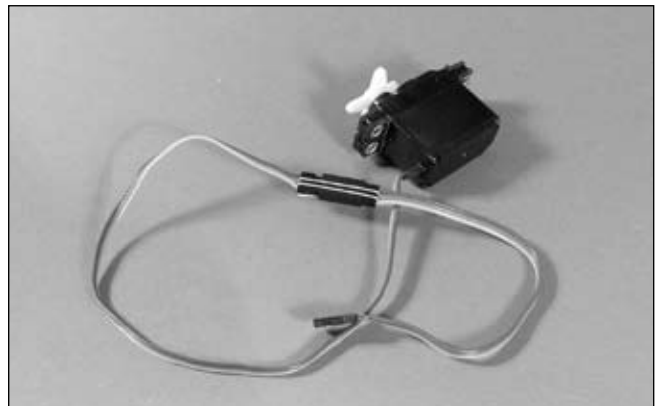

Section 1: Aileron Installation

□ □ Step 9

Slide one of the longer pushrod wires into the wing. Attach the servo extension to the "Z" bend of the pushrod wire.

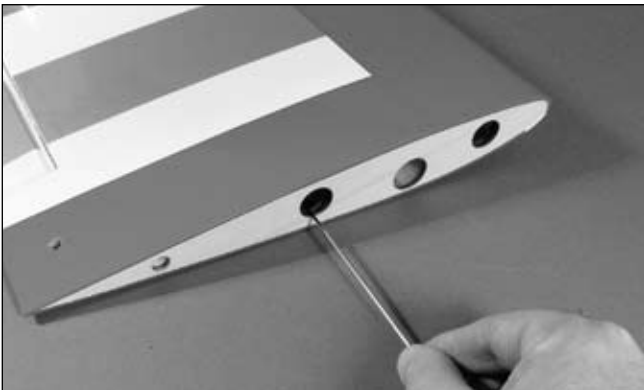
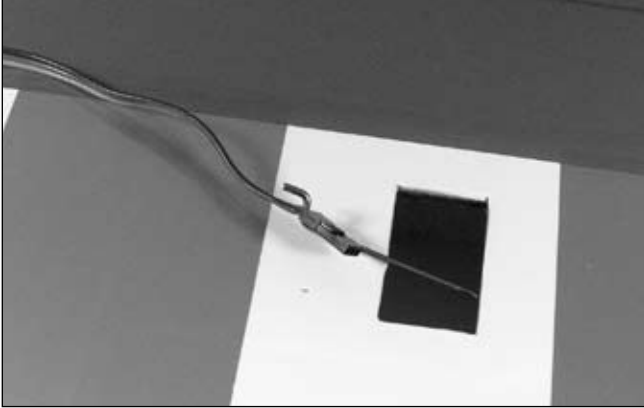

□ □ Step 10

Pull the servo lead through the wing using the pushrod wire. The lead will exit the hole on the top of the wing. Use a piece of tape to keep the extension from falling back into the wing.



□ □ Step 11

Place the servo into the opening with the servo output towards the trailing edge of the wing. Use a felt-tipped pen to mark the locations for the four servo mounting screws.



□ □ Step 12

Remove the servo and drill the locations for the servo mounting screws using a 1/16" (1.5mm) drill bit. Apply a couple drops of thin CA to each hole to harden the wood, which will help in preventing the screws from damaging the wood.

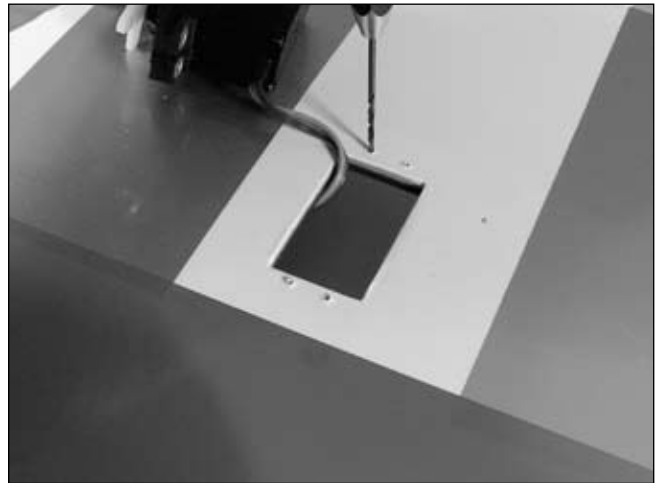

Section 1: Aileron Installation

□ □ Step 13

Secure the servo using the screws provided with the servo.



□ □ Step 14

Slide a clevis retainer onto a clevis. Thread the clevis onto the 4" (102mm) aileron pushrod wire.

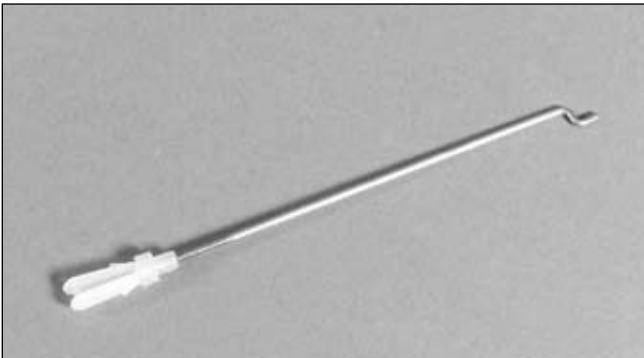

□ □ Step 15

Enlarge the outer hole of the servo arm using a 5/64" (2mm) drill bit. Attach the "Z" bend to the servo arm.

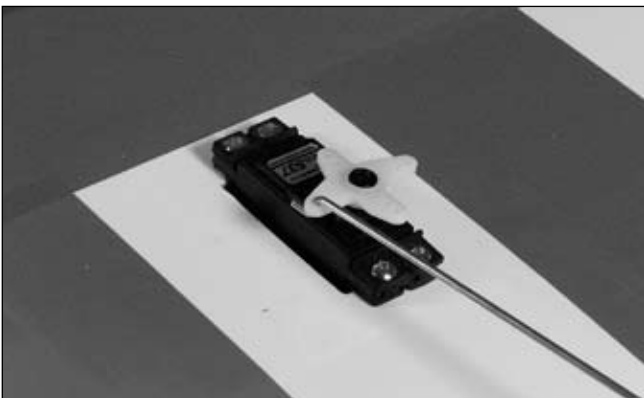

Note: You may want to use tape at the wing tip and wing root to hold the aileron in position for the next few steps.

□ □ Step 16

Plug the aileron servo into the radio system. With the radio on, center the aileron stick and trim. Position the aileron servo arm parallel to the hinge line. Thread the clevis so the pin in the clevis is aligned with the trailing edge of the wing.

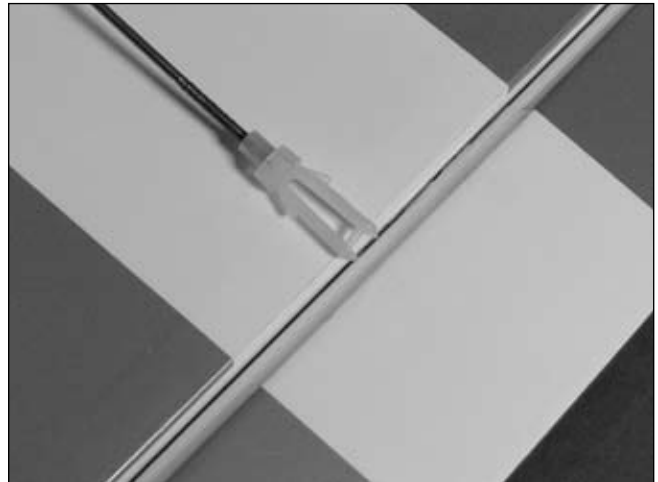

□ □ Step 17

Remove the backplate from a control horn using a hobby knife. Attach the clevis to the center hole of the control horn. Use a felt-tipped pen to mark the locations on the aileron for the three aileron control horn screws.

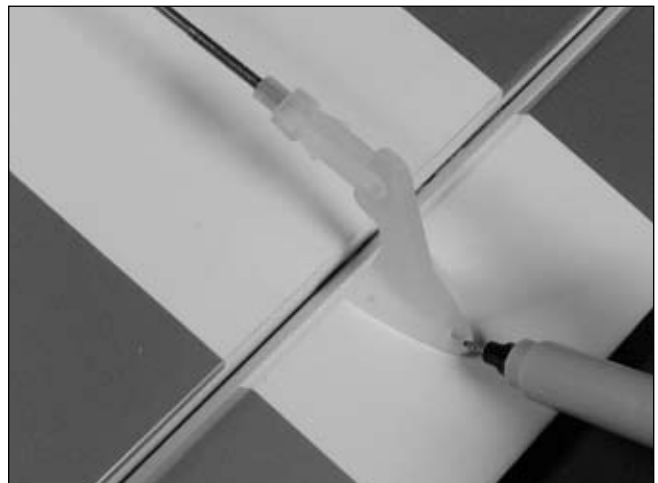

Section 1: Aileron Installation

□ □ Step 18

Use a 5/64" (2mm) drill bit to drill the locations for the control horn screws. Place a few drops of thin CA into each hole to harden the underlying wood. This will help in preventing the wood from crushing when tightening the control horn screws.



□ □ Step 19

Attach the control horn using two 2mm x 16mm screws, a 2mm x 12mm screw and the control horn backplate. The shorter screw goes towards the trailing edge of the aileron.

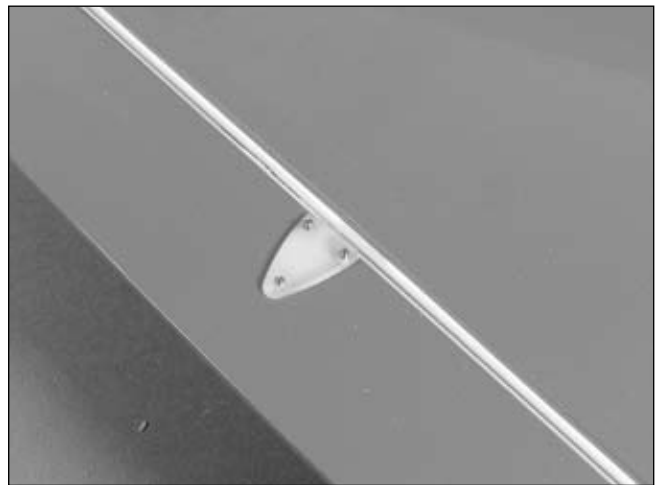
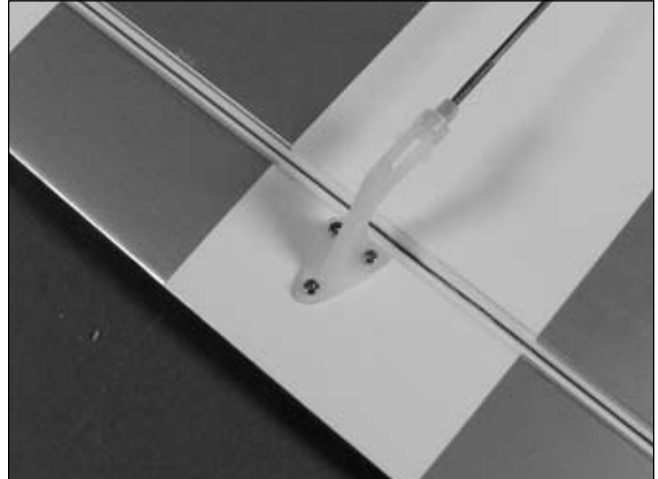

□ Step 20

Repeat Steps 1 through 19 for the remaining wing panel and aileron.

Section 2: Hinging the Stabilizer

Required Parts

- Stabilizer
- Elevator (right and left)
- Elevator joiner wire
- Control horn w/backplate
- 2mm x 12mm screw (3)

Required Tools and Adhesives

- Thin CA
- Drill
- Drill bit: 1/16" (1.5mm)
- Straight edge
- 6-minute epoxy
- Masking tape
- Sandpaper
- Paper towel
- Rubbing alcohol
- Mixing stick
- T-pins
- Phillips screwdriver

□ Step 1

Locate the elevator joiner wire. Use sandpaper to roughen the wire. Use a paper towel and rubbing alcohol to clean the wire to remove any dirt or debris.

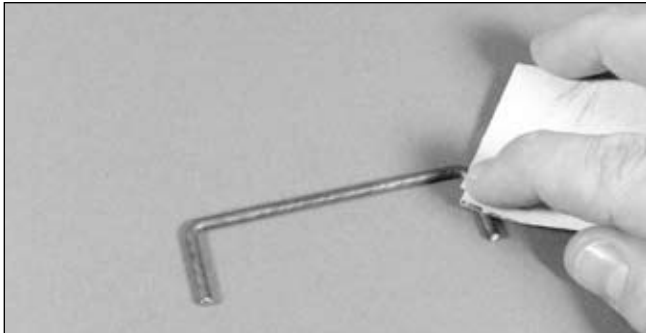

□ Step 2

Test fit the joiner wire into one of the elevator halves. The wire must rest parallel or behind the hinge line of the elevator. Make any adjustments to the elevator to correct any offset.

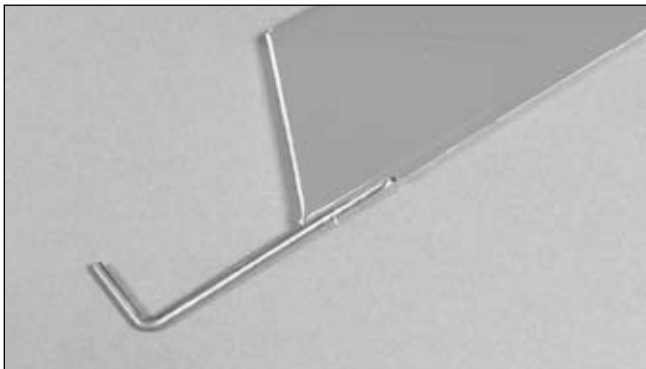

□ Step 3

Mix up a small amount of 6-minute epoxy. Apply epoxy to the hole and groove of the elevator. Also apply epoxy to the joiner wire where it will contact the elevator half. Slide the joiner wire into position and use masking tape to hold it in position until the epoxy cures.

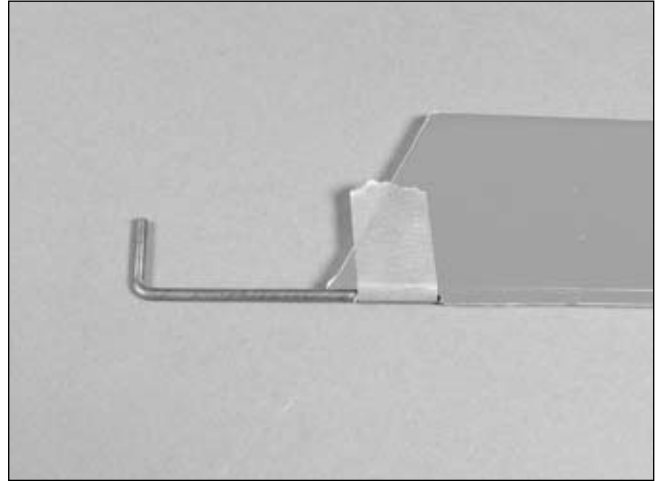

□ Step 4

Test fit the remaining elevator to the joiner wire. There are two items to check: Make sure both elevators rest flat on the work surface, and that the leading edge of both elevators are parallel. Make adjustments to the elevator and/or joiner wire to properly align the two elevator halves.

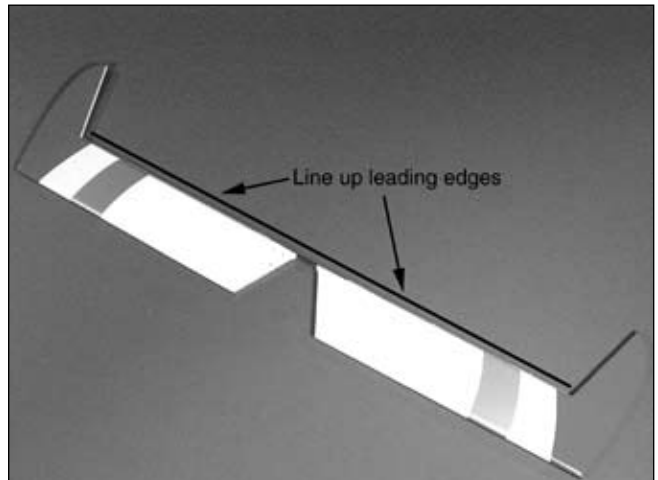

□ Step 5

Use epoxy to glue the joiner into the remaining elevator half.

Section 2: Hinging the Stabilizer

□ Step 6

Drill a 1/16" (1.5mm) hole in the center of each hinge slot in both the elevators and stabilizer. Prepare six CA hinges by placing a T-pin in the center of each hinge. Slide the hinges into the elevators until the T-pins are resting on the leading edge of the elevator.

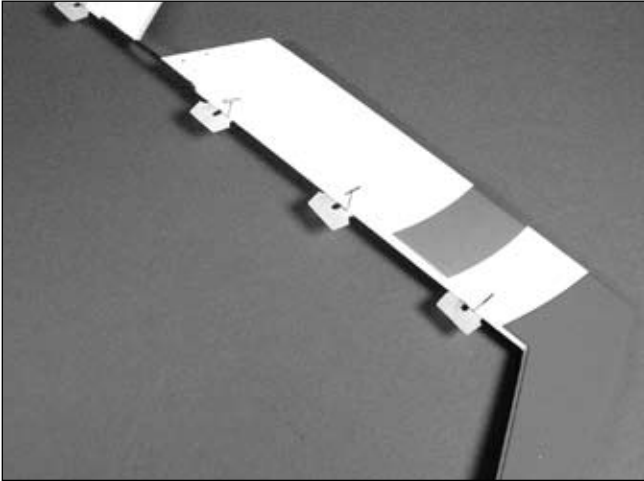

□ Step 7

Slide the elevators onto the stabilizer. Remove the T-pins and use thin CA to glue the hinges. Allow the CA to fully cure before testing and breaking in the hinges using the same technique as the aileron hinges.

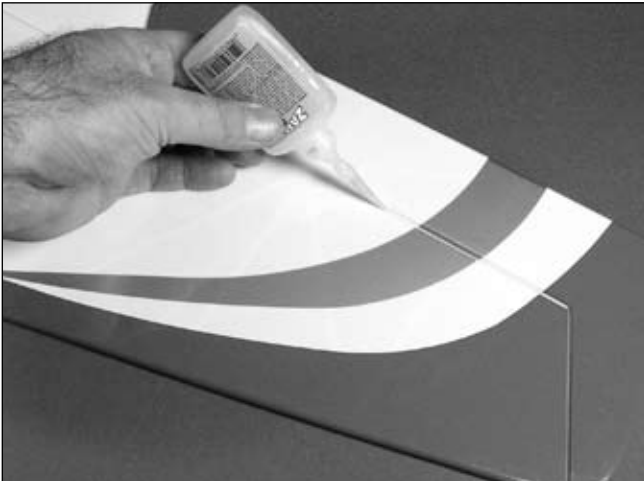

□ Step 8

Since the holes are pre-drilled in the elevator, go ahead and install the control horn using three 2mm x 12mm screws.

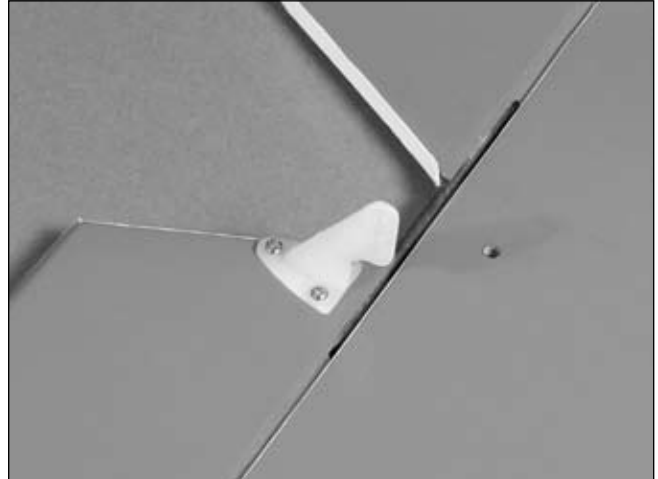

Section 3: Hinging the Rudder

Required Parts

- Rudder
- Tail wheel assembly
- CA hinge (2)
- 2mm wheel collar w/setscrew
- Control horn w/backplate
- 2mm x 12mm screw (3)
- Fin
- Tail wheel 1" (25mm)

Required Tools and Adhesives

- Thin CA
- Hobby knife
- 6-minute epoxy
- Sandpaper
- Rubbing alcohol
- T-pin
- Phillips screwdriver
- Drill bit: 1/16" (1.5mm), 5/64" (2mm)
- Drill
- Felt-tipped pen
- Ruler
- Paper towel
- Mixing stick
- Hex wrench: 1.5mm
- Threadlock

□ Step 1

Locate the tail wheel assembly. Fit the nylon bushing into the rudder post. Use a felt-tipped pen to mark the nylon bearing where it protrudes from the rudder post.

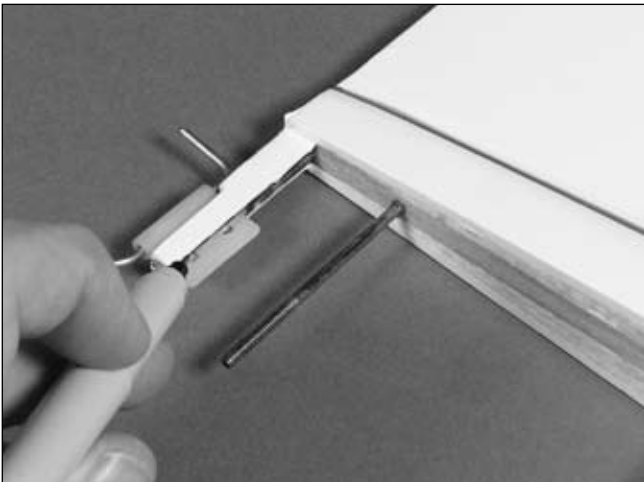

□ Step 2

Use a hobby knife or side cutters to trim the nylon bearing as shown. Drill three 5/64" (2mm) holes in the bearing to give the epoxy something to grab on to when it gets glued into the rudder post.

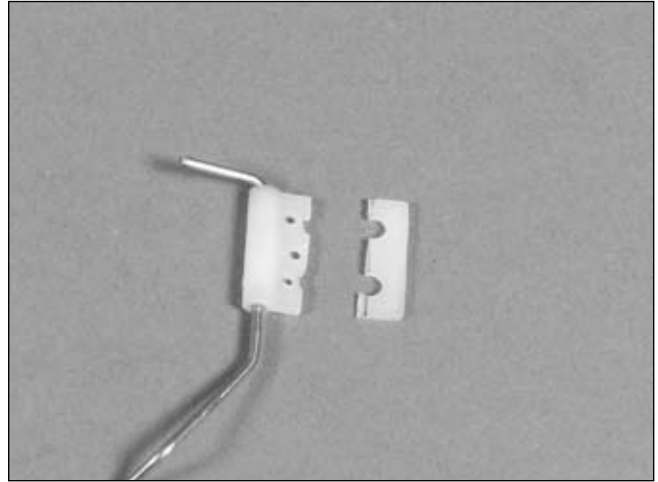

□ Step 3

Apply a thin coat of petroleum jelly to the wire and work it onto the nylon bearing. This will help prevent the epoxy from gluing the wire to the bearing.

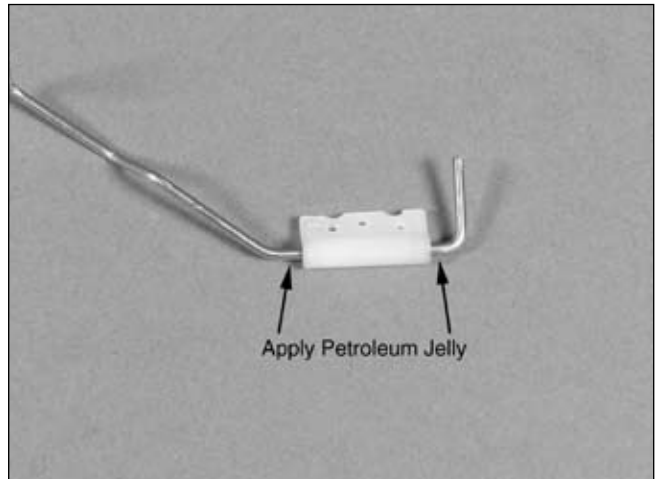

□ Step 4

Use a small amount of 6-minute epoxy to glue the bearing into the rudder post.

□ Step 5

Prepare the hinge slots in the rudder and fin by drilling a 1/16" (1.5mm) hole in the center of each slot. Prepare the last two CA hinges by placing a T-pin in the center of each one.

Section 3: Hinging the Rudder

□ Step 6

Test fit the rudder and fin together. Make sure to insert the tail gear wire into the rudder. When satisfied with the fit, mix up a small amount of 6-minute epoxy and apply it to the tail gear wire and the corresponding hole in the rudder. Slide the rudder back into position against the fin.

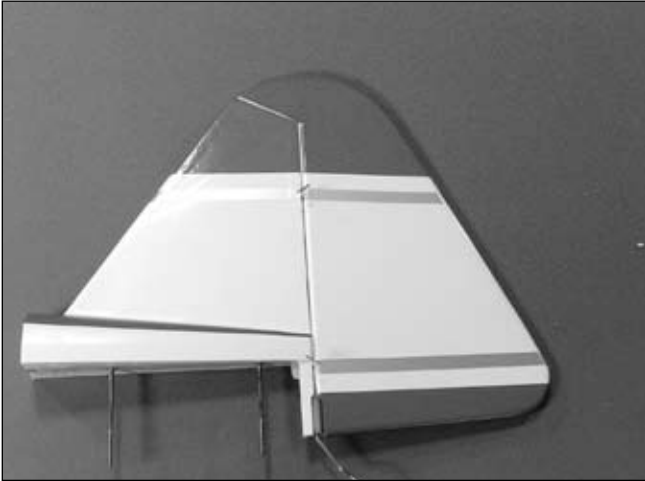

□ Step 7

Position the rudder control horn 5/8" (16mm) up from the bottom of the rudder. With the holes in the horn aligned with the hinge line, mark the locations for the control horn screws. Drill the locations using a 5/64" (2mm) drill bit. After placing a few drops of thin CA into each hole, secure the control horn using three 2mm x 12mm screws.

Note: The horn will be on the right side of the plane from the pilot's perspective.

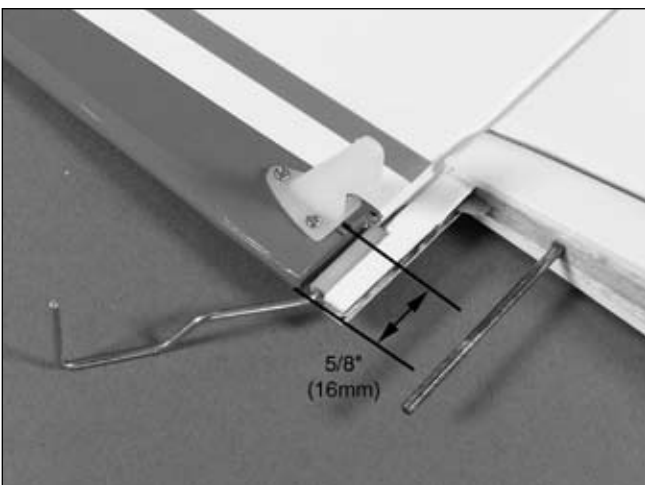

□ Step 8

Attach the tail wheel using the 2mm wheel collar and setscrew. Use threadlock on the setscrew to prevent it from coming loose in flight due to vibration.

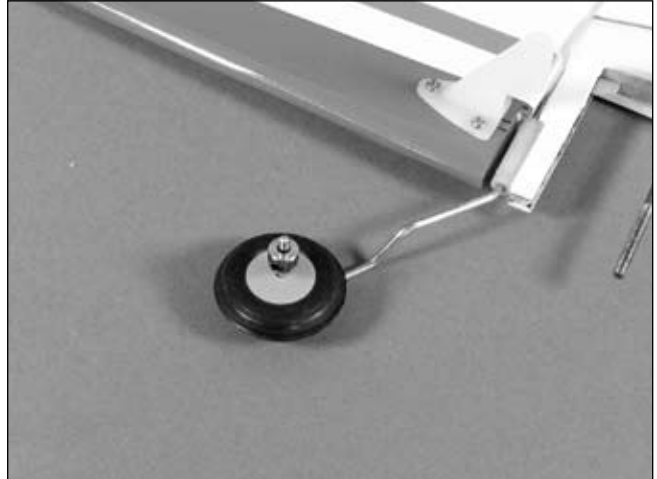

Section 4: Landing Gear Installation

Required Parts

- Fuselage
- Landing gear
- 4mm nut (6)
- 4mm locknut (2)
- 6-32 x 1/2" socket head screw (3)
- 4-40 blind nut (4)
- #6 washer (3)
- 2 3/4" (70mm) wheel (2)
- Wheel pant (right and left)
- 4-40 x 3/8" socket head bolt (4)
- 4mm x 40mm socket head bolt (2)

Required Tools and Adhesives

- Hex wrench: 3/32", 7/64"
- Drill
- Drill bit: 9/64" (3.5mm)
- Threadlock
- Felt-tipped pen

□ Step 1

Attach the landing gear to the bottom of the fuselage using three 6-32 x 1/2" socket head bolts and three #6 washers. Put a little threadlock on the bolts to prevent them from vibrating loose during flight.

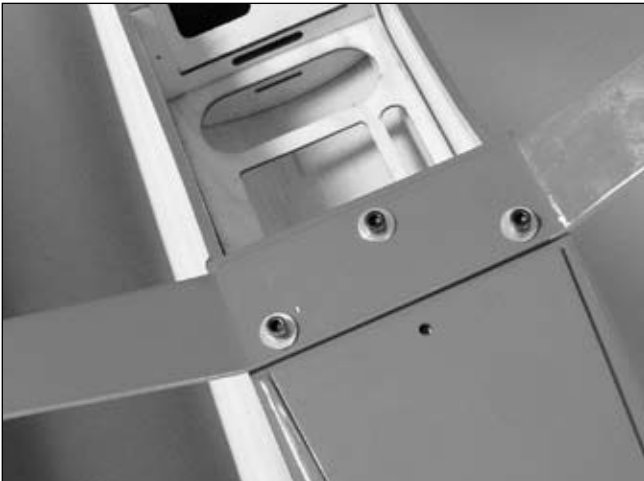

□ □ Step 2

Slide a 4mm x 40mm socket head bolt into a wheel. Slide a 4mm washer onto the bolt then thread a 4mm nut onto the bolt. Leave the bolt loose enough that the wheel can spin freely on the bolt. Use a drop of thin CA or threadlock to keep the nut in position.

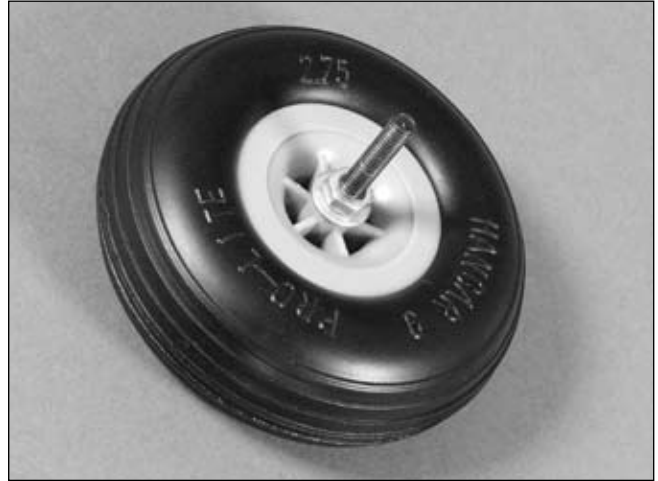

□ □ Step 3

Thread a second 4mm nut onto the bolt. Slide the bolt into the landing gear. Place a second 4mm washer onto the bolt, then start the 4mm locknut onto the bolt. The order is: wheel, 4mm nut, 4mm washer, 4mm nut, landing gear, 4mm washer and 4mm locknut.



Section 4: Landing Gear Installation

□ □ Step 4

Position the inner 4mm nut so there is about 7/16" (12mm) between the wheel nut and landing gear. Tighten the 4mm locknut onto the screw. The distance may require some adjustment once the wheel pants have been installed.

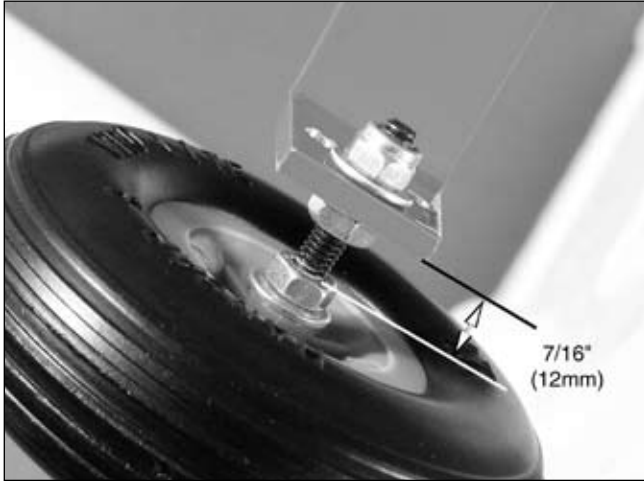

□ Step 5

Repeat Steps 2 through 4 for the remaining wheel.

□ □ Step 6

Place the wheel pant over the wheel. Position the wheel pant so it is parallel to the fuselage centerline. Mark the location for the two screws from the back of the wheel pant using a felt-tipped pen.

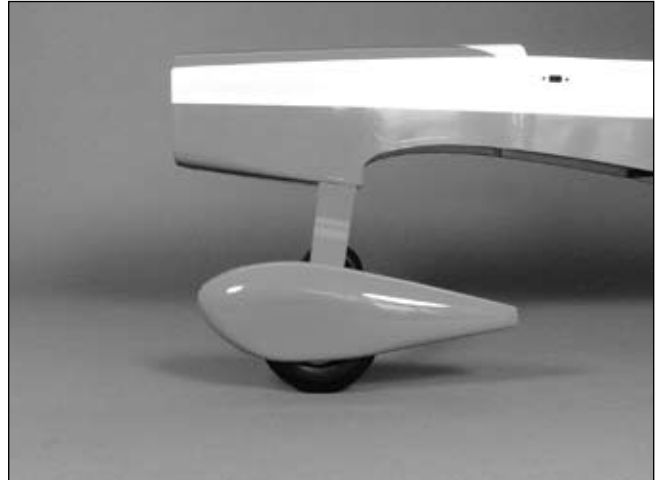

Section 4: Landing Gear Installation

Step 7

Use a 9/64" (3.5mm) drill bit to drill the two locations for the screws.

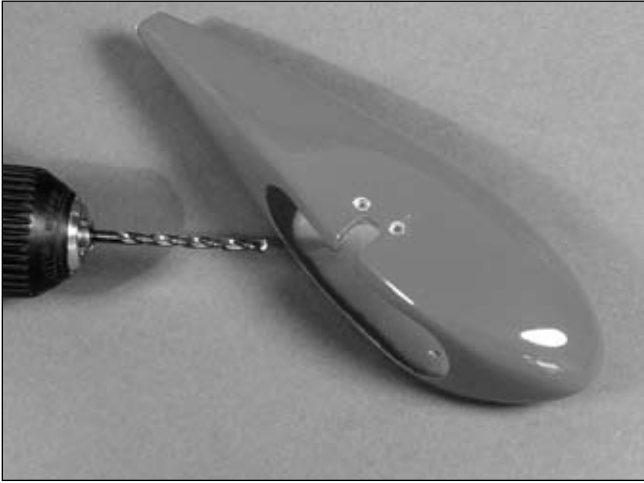

Step 8

Install two 4-40 blind nuts inside the wheel pants through the holes drilled in the previous step.



Step 9

Secure the wheel pant to the landing gear using two 4-40 x 3/8" socket head screws. Make sure to use threadlock to prevent the screws from loosening during flight.



Step 10

Check that the wheel can spin freely without rubbing on the wheel pant. If it does, loosen the 4mm nut and 4mm locknut and reposition the wheel so it can spin freely.

Step 11

Repeat Steps 6 through 10 to install the remaining wheel pant.

Section 5: Servo Installation

Required Parts

- Fuselage
- 23³/₈" (594mm) rudder pushrod
- 22¹/₂" (572mm) elevator pushrod wire
- Clevis w/retainer

Required Tools and Adhesives

- Drill
- Switch harness
- Phillips screwdriver
- Drill bit: 1/16" (1.5mm), 5/64" (2mm)
- Felt-tipped pen
- Standard servo (3)

Note: The throttle servo is not required when building the electric version of your Pulse XT.

Step 1

If you choose to use a glow engine, place the throttle servo into the fuselage. Use a felt-tipped pen to mark the locations for the four servo mounting screws on the radio tray.

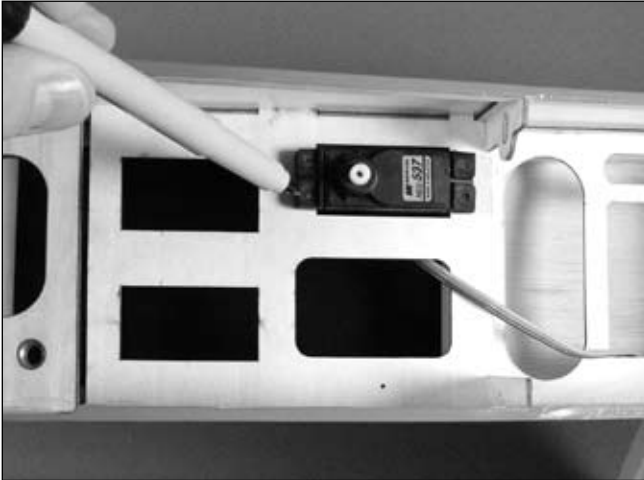

Step 2

Use a 1/16" (1.5mm) drill bit to drill the locations for the screws. Place a drop of thin CA into each of the holes to harden the surrounding wood.

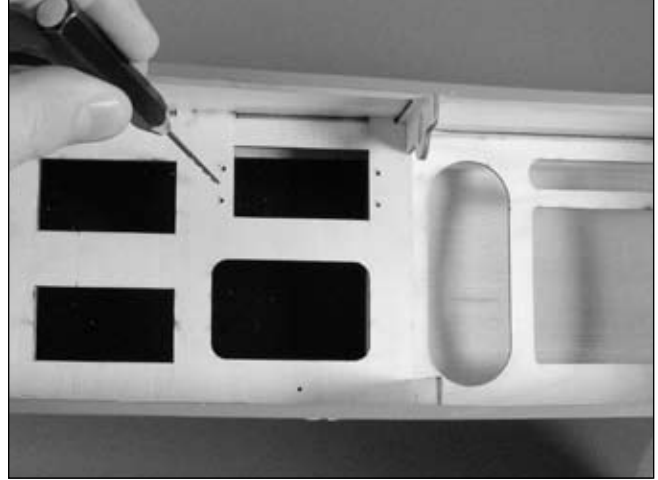

Step 3

Secure the throttle servo using the hardware supplied with the servo. Don't forget to install the grommets and brass eyelets before installing the servo.



Section 5: Servo Installation

□ Step 4

Repeat Steps 1 through 3 to install the rudder and elevator servos.

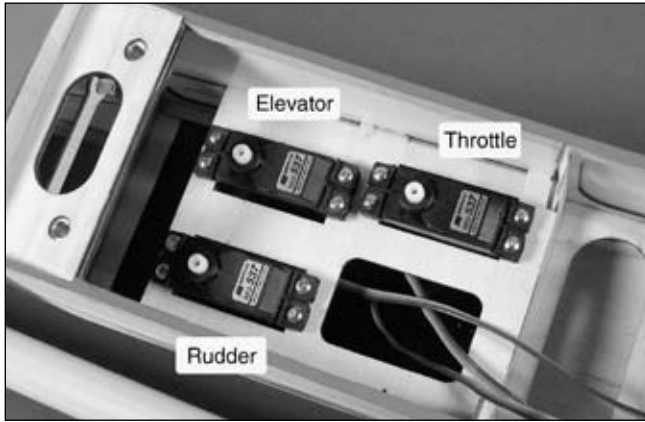

□ Step 5

Install the switch harness on the side of the fuselage using the switch harness hardware.



□ Step 6

Wrap the receiver and receiver battery in 1/4" (6mm) foam to protect them from engine vibrations.

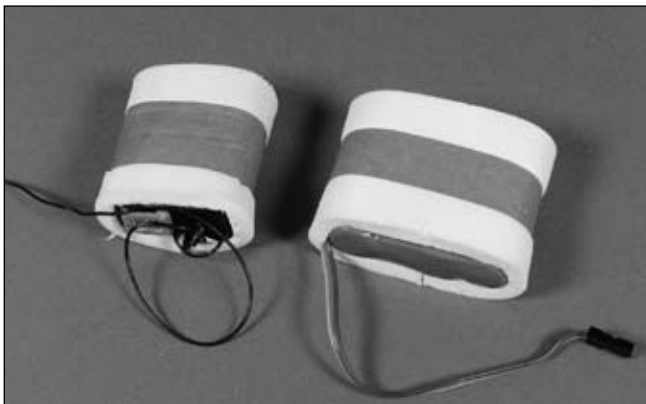

□ Step 7

Plug the servos, extensions and switch harness into the receiver. Plug the receiver battery and switch harness together. Place the receiver and receiver battery into the fuselage.

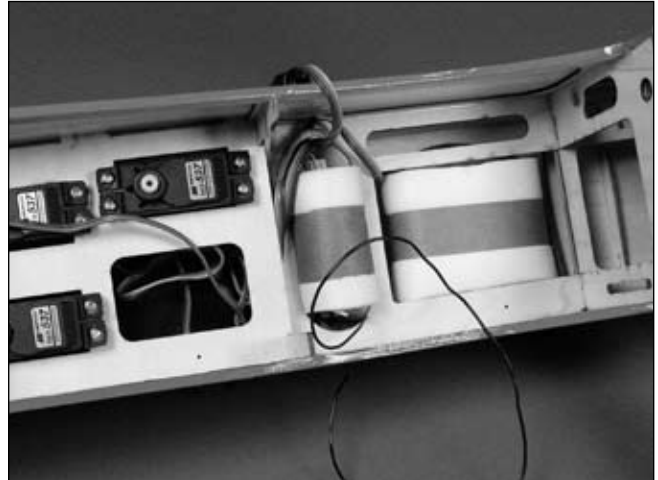

□ Step 8

Route the receiver antenna to the rear of the fuselage using the pre-installed antenna tube.

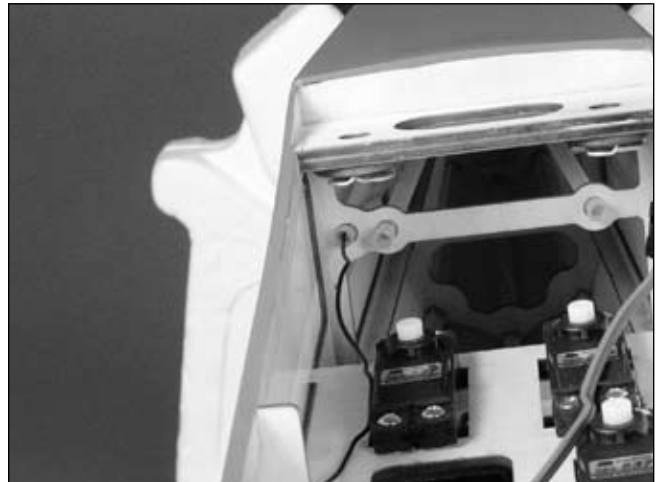

Note: Do not cut the excess antenna wire as it will reduce the range of your radio system.

Section 5: Servo Installation

□ □ Step 9

Attach the $23\frac{3}{8}$ " (594mm) rudder pushrod to the servo arm using the "Z" bend in the pushrod. You may need to use a $5/64$ " (2mm) drill bit to enlarge the hole in the servo arm to accept the wire.

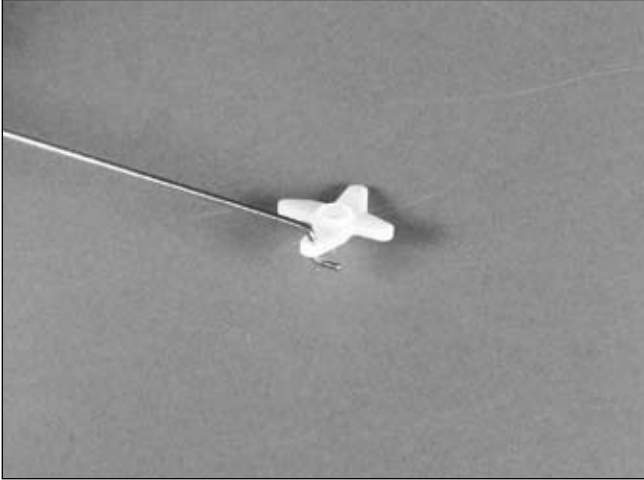

□ □ Step 10

Turn the radio system on and center the rudder stick and rudder trim. Slide the pushrod wire into the pushrod tube. Secure the servo arm to the servo using the screw included with the servo.



□ □ Step 11

Slide a clevis retainer onto a clevis. Thread the clevis onto the rudder pushrod.

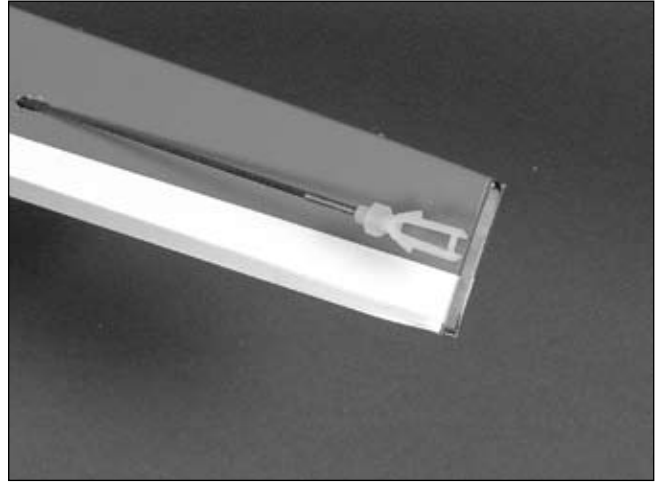

□ Step 12

Repeat Steps 9 through 11 for the $22\frac{1}{2}$ " (572mm) elevator pushrod wire.



Section 6A: Tail Installation

Required Parts

- Fuselage
- Stabilizer assembly
- #4 washer
- Rudder assembly
- 4-40 locknut (2)

Required Tools and Adhesives

- Adjustable wrench

Step 1

Carefully slide the threaded rods from the rudder assembly into the stabilizer assembly.

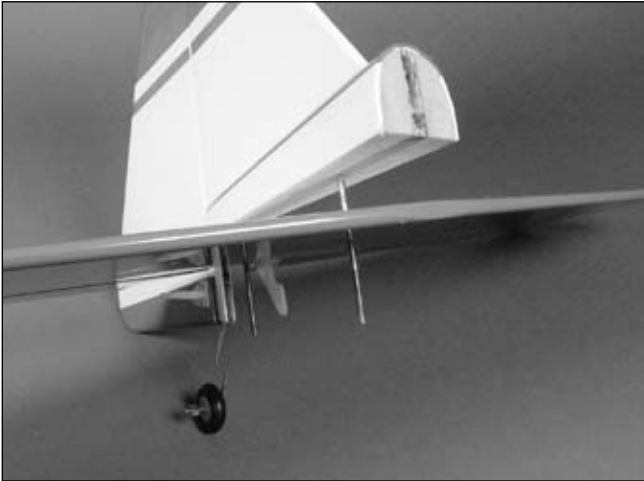

Step 2

Slide the tail assembly into position on the fuselage.

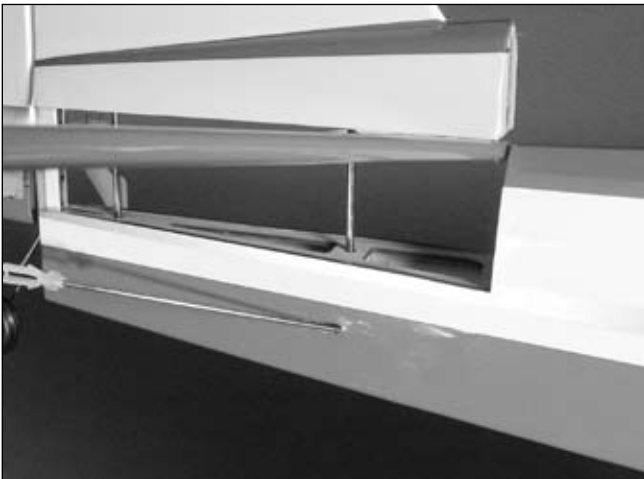

Step 3

Secure the tail assembly to the fuselage using two 4-40 locknuts and two #4 washers.

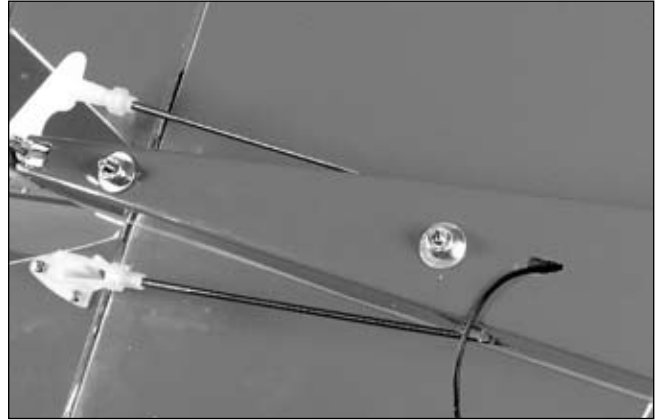

Note: Do not over-tighten the nuts and crush the fuselage.

Step 4

Connect the rudder clevis to the rudder control horn. With the radio system on, check that the rudder is centered. If not, either thread the clevis on or off the pushrod until the rudder is centered.

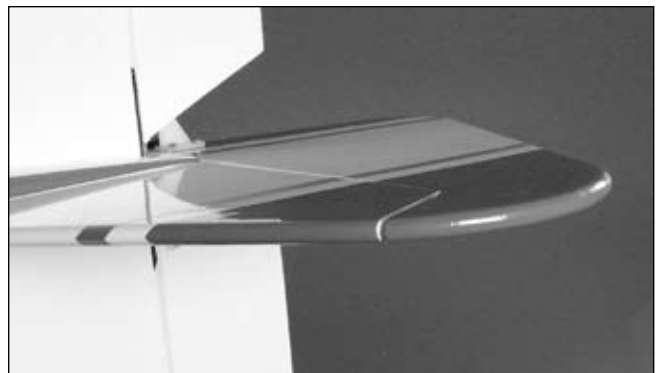
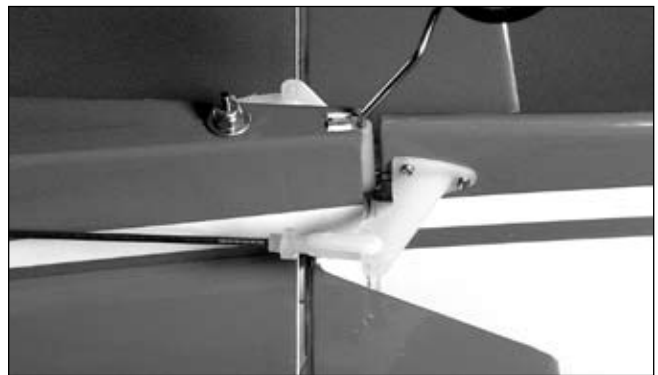

Section 6A: Tail Installation

Step 5

Repeat Step 4 for the elevator.

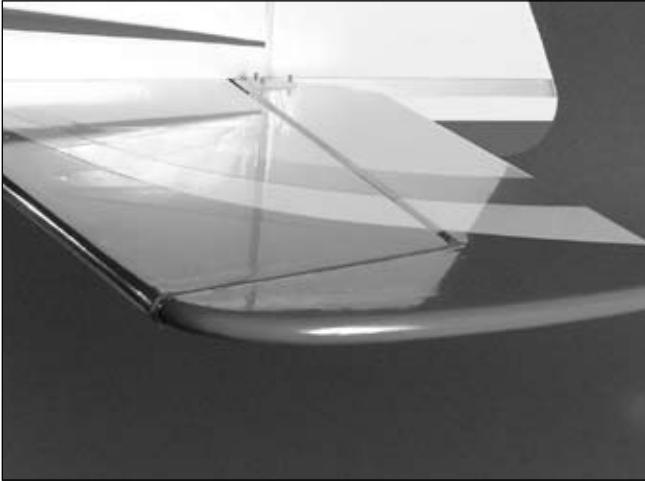

Section 6B: Gluing the Tail (Optional)

Required Parts

- Fuselage w/tail installed

Required Tools and Adhesives

- Adjustable wrench
- Hobby knife
- Straight edge
- Felt-tipped pen
- 30-minute epoxy

This section is optional and describes how to permanently glue the tail section to the fuselage. If you do not want to glue the tail to the fuselage, feel free to continue to Section 7: Engine Installation.

□ Step 1

Use a felt-tipped pen to trace the outline of the fuselage onto the bottom of the stabilizer. Also trace the outline of the fin fairing onto the top of the stabilizer using a felt-tipped pen.

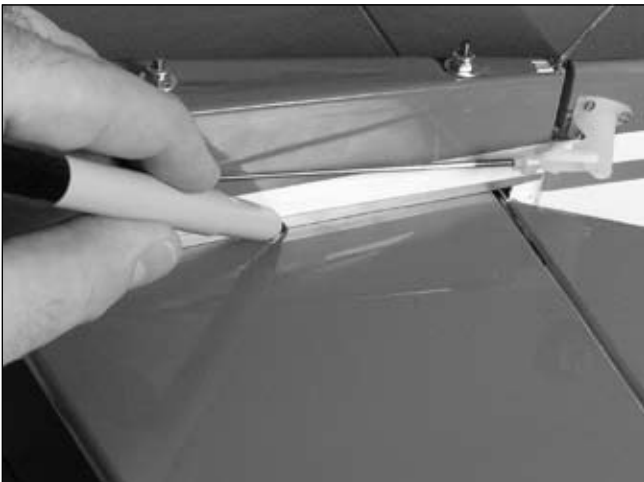
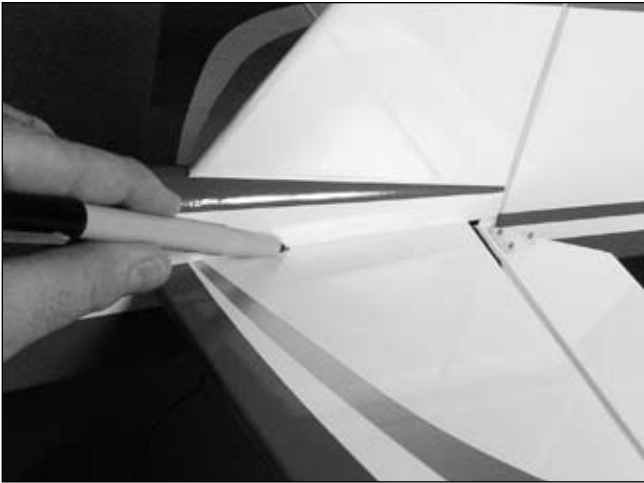

□ Step 2

Remove the tail from the fuselage. Use a straight edge and hobby knife to trim the covering about 1/16" (1.5mm) inside the lines drawn on the top and bottom of the stabilizer.

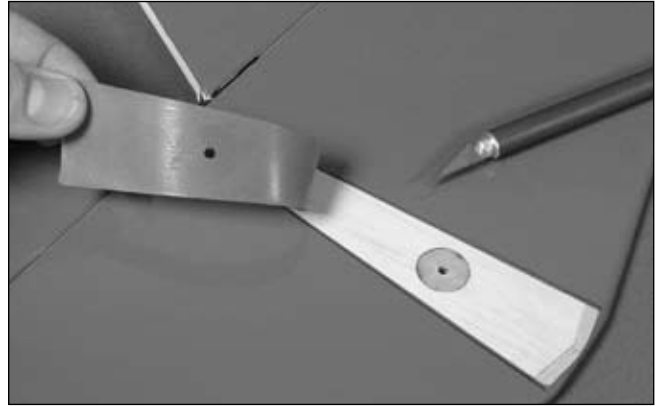

Note: Be very careful when cutting the covering. Using too much pressure can go through the covering and into the stabilizer. Doing so will score the stabilizer and it may fail in flight.

Hint: Use a soldering iron or hot knife to trim the covering on the stabilizer. This will lower the chances of scoring the stabilizer.

□ Step 3

Mix about 1/2 oz (15ml) of 30-minute epoxy. Apply the epoxy to the exposed wood on both the top and bottom of the stabilizer. Install the tail back onto the fuselage as described in Section 6. Use a paper towel and rubbing alcohol to remove any excess epoxy before it has a chance to cure.



Section 7A: Electric Motor Installation

Required Parts

- Fuselage
- Plywood battery tray
- Hook and loop strap
- Cowling
- 4-40 x 3/8" socket head screw (2)
- 6-32 x 1 7/8" screw (4)
- 6-32 x 1 7/8" screw (4)
- 1" (25mm) aluminum motor spacer (4)
- Hook and loop (adhesive back)
- #2 x 1/2" sheet metal screw (2)

Required Tools and Adhesives

- Phillips screwdriver
- Threadlock
- Hex wrench: 3/32"
- Drill
- Male Deans connector (3)
- Soldering iron
- Drill bit: 9/64" (3.5mm)
- Female Deans connector w/wire
- Solder
- 4200mAh 2S2P 7.4V Li-Po (2)

□ Step 1

Enlarge the outer mounting holes in the X-mount of the motor using a 9/64" (3.5mm) drill.

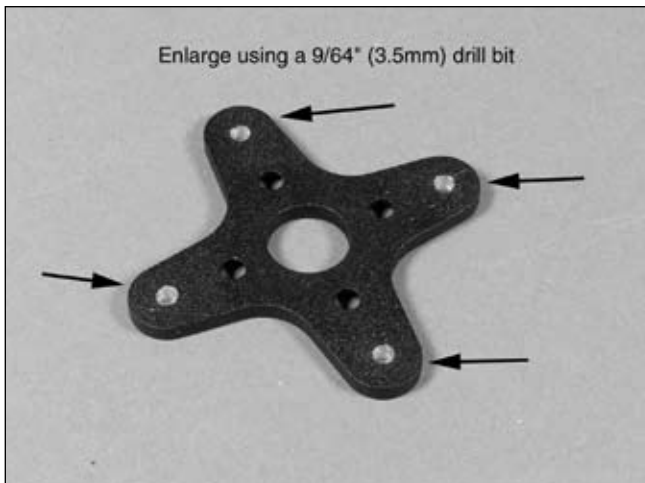

□ Step 2

Attach the X-mount to the back of the motor using the hardware provided with the motor. Remember to put a drop of threadlock on each of the screws to prevent them from vibrating loose.



□ Step 3

Attach the motor to the firewall using the 1" (25mm) spacers and 6-32 x 1 7/8" screws. Use threadlock on the screws here as well.



Section 7A: Electric Motor Installation

□ Step 4

Build a wiring harness for the batteries using a female connector and two male connectors. Follow the wiring in the photo so the motor sees the voltage increase of the two batteries.

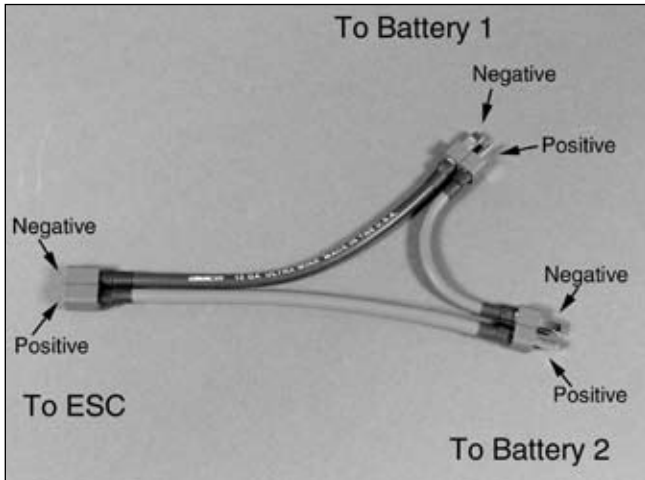

□ Step 5

Solder the appropriate connectors onto the speed control.

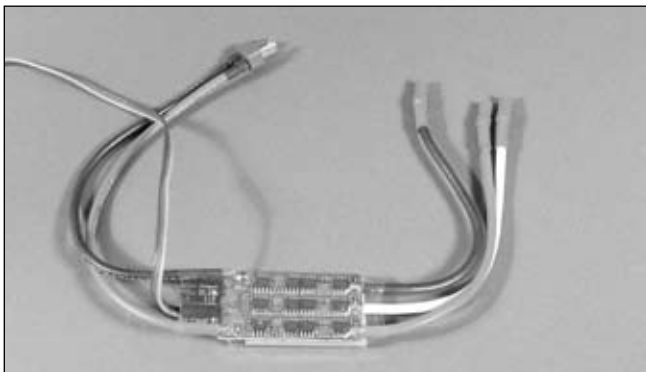

□ Step 6

Remove the covering from the bottom of the fuselage as shown to allow for cooling air across the motor and batteries.



□ Step 7

Prepare the battery tray by applying two pieces of self adhesive hook and loop to the battery tray. Start the hook and loop directly behind the holes in the tray.

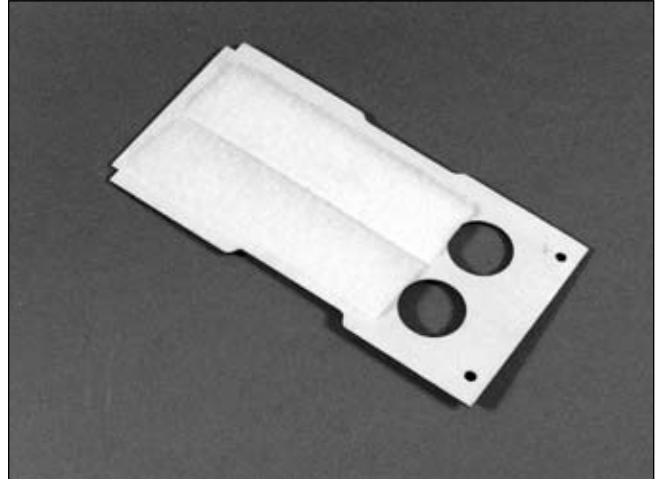

□ Step 8

Position the hook and loop strap into the fuselage. Route the strap through the fuselage bracing as shown.

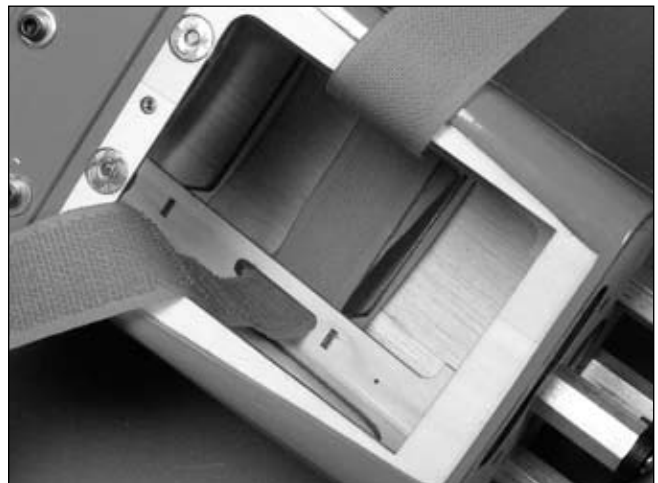

Section 7A: Electric Motor Installation

□ Step 9

Remove the hatch from the bottom of the fuselage. Slide the battery tray into the fuselage with the hook and loop facing towards the bottom. The rear of the battery tray will key into the former. Use two 4-40 x 3/8" socket head screws to secure the front of the battery tray.

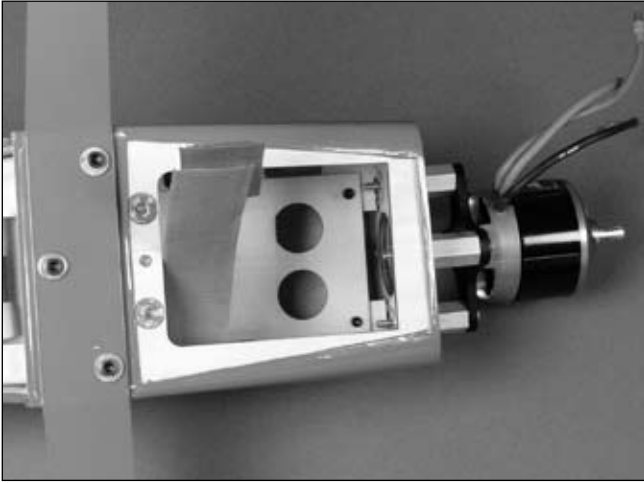

□ Step 10

Plug the motor into the speed control. Place the mating half of the self adhesive hook and loop onto each of the batteries. Secure the batteries using the hook and loop strap. Plug the speed control into the receiver. Mount the speed control inside the fuselage so it will not interfere with the installation and removal of the batteries.



□ Step 11

Turn on the radio system. Plug the wiring harness assembled in Step 4 into the batteries and speed control. Use the throttle on the transmitter to check that everything is working correctly. Check that the motor is rotating counterclockwise. If not, follow the directions included with the speed control to correct the situation.

□ Step 12

Once the motor is working and rotating in the correct direction, unplug the wiring harness for safety. Snap the battery hatch back onto the fuselage.

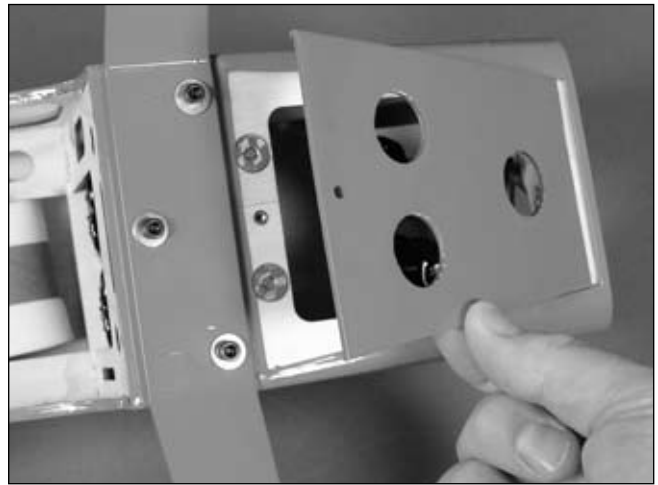

□ Step 13

Trim the cowling as necessary to fit over the motor. The cowl is mounted using four #2 x 1/2" sheet metal screws. Install the propeller and spinner using the instructions included with your particular motor.



Section 7B: Glow Engine Installation

Required Parts

- Fuselage
- Cowling
- 6-32 locknut (4)
- Clevis w/retainer
- 3mm x 6mm screw
- 6-32 x 3/4" screw (4)
- 6-32 x 1 1/4" screw (4)
- Pushrod connector w/backplate
- #2 x 1/2" sheet metal screw (4)
- 4-40 x 1/2" socket head screw
- Engine mount (2)
- Fuel tank
- #6 washer (4)
- Throttle pushrod
- Thick foam

Required Tools and Adhesives

- Drill
- Phillips screwdriver
- Drill bit: 5/64" (2mm), 5/32" (4mm)

□ Step 1

Mount the engine mount onto the firewall using four 6-32 x 3/4" screws.



□ Step 2

Position the engine on the engine mount so the drive washer is 4" (102mm) ahead of the firewall.

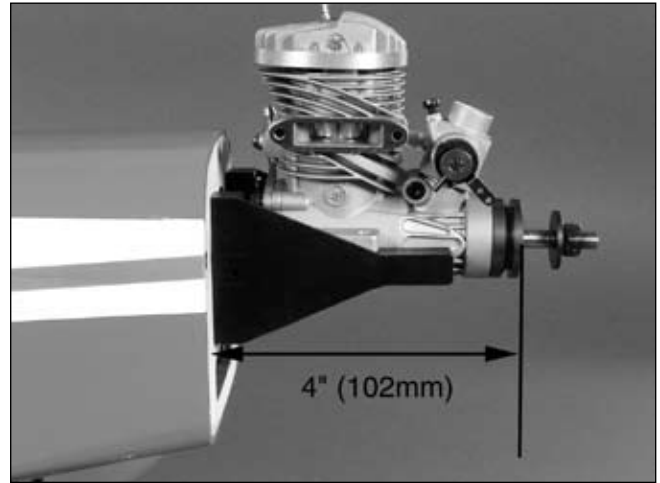

□ Step 3

Mark the location of the engine mounting bolts using a felt-tipped pen. Drill the engine mount using a 5/32" (4mm) drill bit.

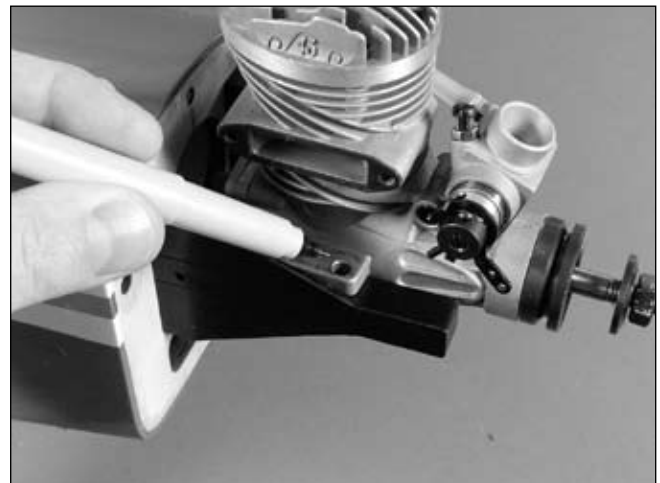

Section 7B: Two-Stroke Engine Installation

□ Step 4

Mount the engine to the mount using four 6-32 x 1 1/4" screws, four #6 washers and four 6-32 locknuts.

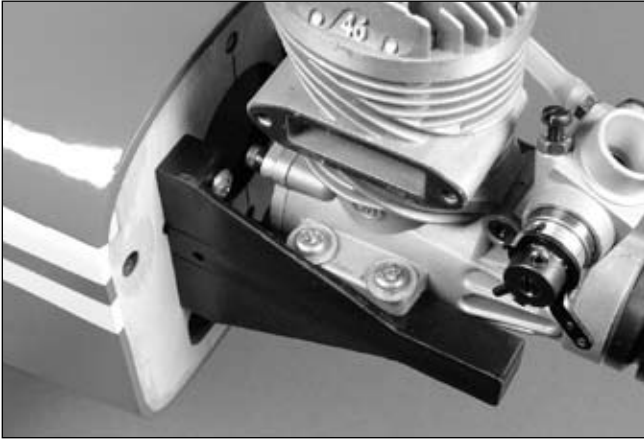

□ Step 5

Slide a clevis retainer onto a clevis, and then thread the clevis onto the throttle pushrod. Slide the pushrod into the pushrod tube and attach the clevis to the carburetor arm.



□ Step 6

Attach the pushrod connector to the throttle servo arm using the connector backplate. You will need to enlarge the hole in the servo arm using a 5/64" (2mm) drill bit.



□ Step 7

Turn on the radio system and center the throttle stick and trim. Slide the pushrod into the brass connector. Place the servo horn onto the servo so the horn is perpendicular to the servo centerline.

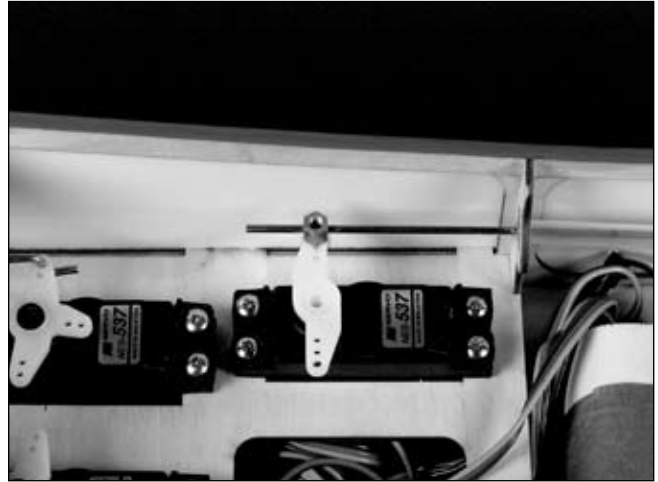

□ Step 8

Use the radio to move the throttle to the low setting using the stick and trim. Move the pushrod so the carburetor is closed. Secure the pushrod wire using a 3mm x 5mm screw.



□ Step 9

Check that the throttle operates from the radio without binding at low and high throttle. Use the ATV setting of the radio or change the position of the clevis at the carburetor or the pushrod connector at the servo to eliminate any binding.

Section 7B: Two-Stroke Engine Installation

□ Step 10

Locate the fuel tank. Hold the tank up to a strong light to determine which direction the vent line is facing. This will be the top of the tank. The red tube is attached to the vent line of the tank. Place the tank inside the fuselage with the vent towards the top of the fuselage.

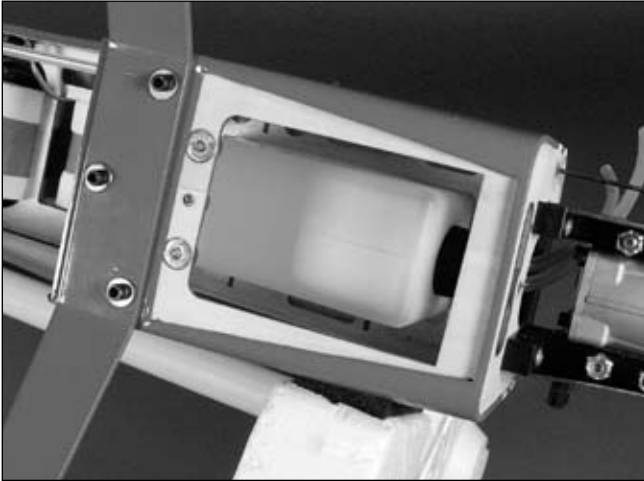

□ Step 11

Place the thick piece of foam into the fuselage to hold the tank in position

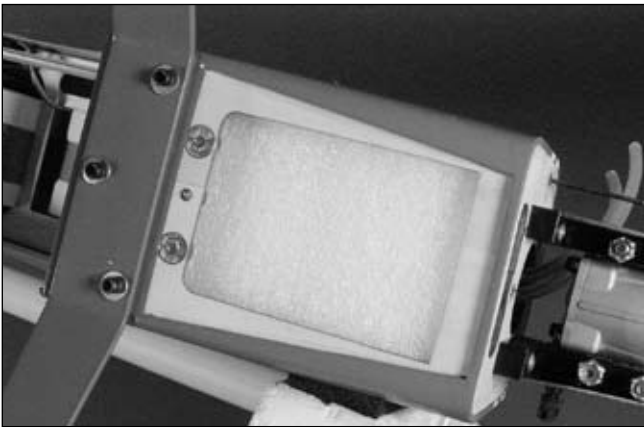

Note: Remember the plane is upside down right now, so the vent will be facing down during installation.

□ Step 12

Place the fuselage hatch into position and secure it using the 4-40 x 1/2" socket head screw.

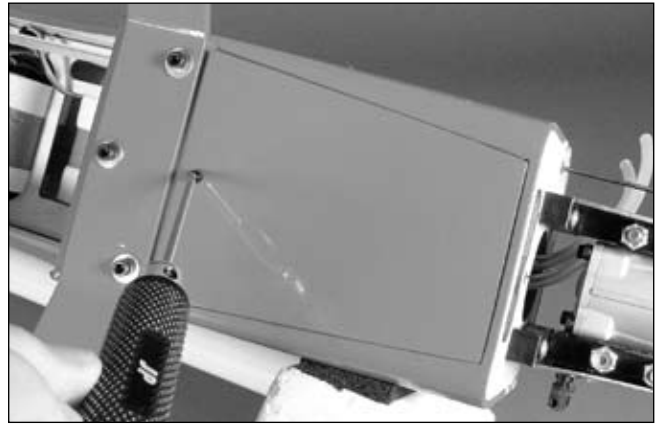

□ Step 13

Trim the cowling as necessary to fit over the motor. The cowl is mounted using four #2 x 1/2" sheet metal screws. Install the propeller and spinner using the instructions included with your particular motor.



Section 8: Final Assembly

Required Parts

- Fuselage
- Wing
- Wing bolt plate
- Wing tube
- 1/4-20 x 1 1/2" nylon bolt (2)
- 1 7/8" (48mm) wing dowel (2)
- 1 5/16" (33mm) wing dowel
- 2mm x 8mm sheet metal screw (4)

Required Tools and Adhesives

- Thin CA
- Phillips screwdriver

□ Step 1

Cut the instrument panel decal from the decal sheet. Apply the decal in position for the instrument panel in the cockpit.



□ Step 2

Use four 2mm x 18mm screws to secure the canopy onto the fuselage. Make sure the rear screws are going into solid wood before installing them.



□ Step 3

Apply any remaining decals onto the aircraft using either the box for location or your imagination.

□ Step 4

Slide the 1 7/8" (48mm) wing dowel into one of the wing panels. Leave 3/8" (10mm) of the dowel extended out from the leading edge of the wing. Apply thin CA to the dowel at the leading edge. You will also see a small portion of the dowel exposed inside the wing. Apply thin CA to the dowel inside the wing as well.

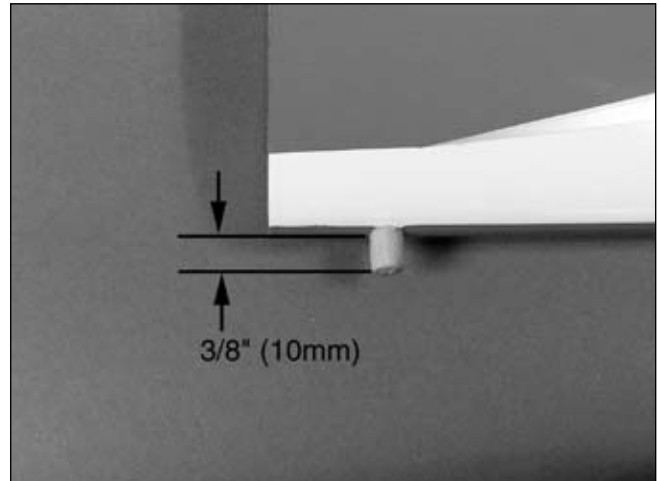

□ Step 5

Slide the wing tube and the 1 5/16" (33mm) wing dowel into one of the wing panels.



Section 8: Final Assembly

□ Step 6

Slide the remaining wing panel onto the wing tube aligning the dowel into the panel.

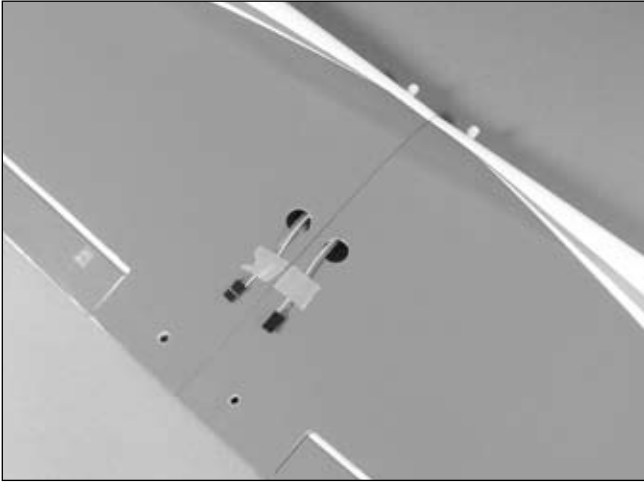

□ Step 7

Slide the 1/4-20 x 1 1/2" wing bolts through the wing bolt plate. Position the wing dowels into the holes in the fuselage. Slide the bolts through the wing and tighten them to secure the wing to the fuselage.

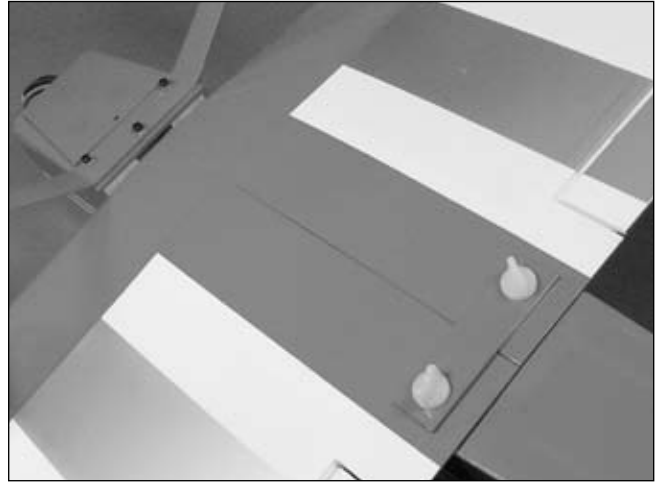

Control Throws

The amount of control throw should be adjusted as closely as possible using mechanical means, rather than making large changes electronically at the radio. By moving the position of the clevis at the control horn toward the outermost hole, you will decrease the amount of control throw of the control surface. Moving it toward the control surface will increase the amount of throw. Moving the pushrod wire at the servo arm will have the opposite effect: Moving it closer to center will decrease throw, and away from center will increase throw. Work with a combination of the two to achieve the closest or exact control throws listed.

Aileron

Low Rate	Up	Down
	11/32" (9mm)	11/32" (9mm)
High Rate		
	1/2" (13mm)	1/2" (13mm)

Elevator

Low Rate	Up	Down
	1/2" (13mm)	1/2" (13mm)
High Rate		
	7/8" (22mm)	7/8" (22mm)

Measured at the trailing edge of the elevator.

Rudder

- 3/4" (19mm) Left
- 3/4" (19mm) Right

The rudder throw is measured at the counter balance using the top of the fin as a reference.

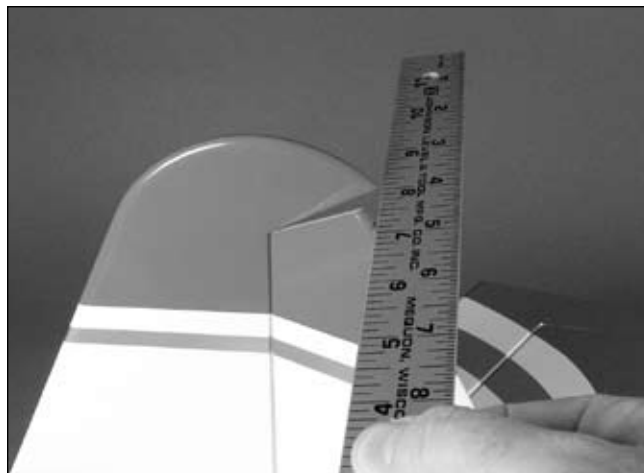

Once the control throws have been set, use the supplied tubing on each clevis to prevent them from opening during flight.



Recommended Center of Gravity (CG)

An important part of preparing the aircraft for flight is properly balancing the model. This is especially important when various engines are mounted.

Caution: Do not inadvertently skip this step!

The recommended Center of Gravity (CG) location for the Pulse XT is $2\frac{3}{4}$ " (70mm) behind the leading edge of the wing against the fuselage. Make sure the aircraft is inverted when measuring the CG. If necessary, move the battery pack or add weight to either the nose or the tail until the correct balance is achieved. Stick-on weights are available at your local hobby store and work well for this purpose.

Note: The range for the center of gravity is $2\frac{1}{2}$ " (63mm) to 3" (76mm).

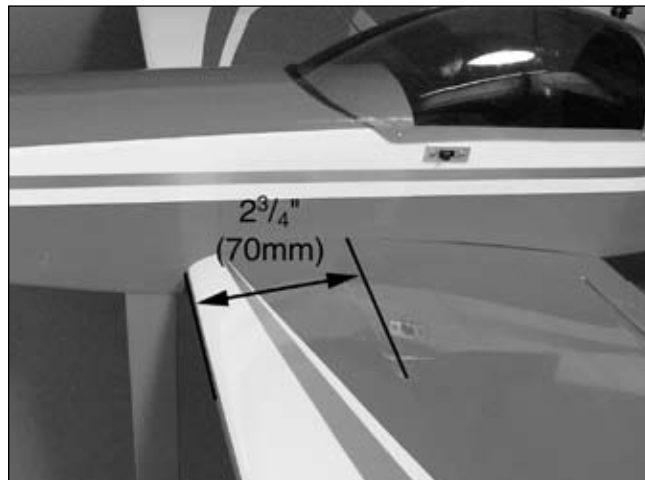

Pre-Flight

Charge both the transmitter and receiver pack for your airplane. If you are flying an electric version, make sure to charge the motor battery as well. Use the recommended charger supplied with your particular radio system, following the instructions provided with the radio. In most cases, the radio should be charged the night before going out flying.

Check the radio installation and make sure all the control surfaces are moving correctly (i.e. the correct direction and with the recommended throws).

Check all the control horns, servo horns and clevises to make sure they are secure and in good condition. Replace any items that would be considered questionable. Failure of any of these components in flight would mean the loss of your aircraft.

Glow Powered:

Test run the engine and make sure it transitions smoothly from idle to full throttle and back. Also ensure the engine is tuned according to the manufacturer's instructions, and it will run consistently and constantly at full throttle when adjusted.

Electric Powered:

Make sure the motor battery has been fully charged and is secure inside the fuselage. Operate the motor and make sure it operates smoothly from low throttle to full throttle and back.

Range Test Your Radio

Range check your radio system before each flying session. This is accomplished by turning on your transmitter with the antenna collapsed. Turn on the radio in your airplane. With your airplane on the ground,

you should be able to walk 30 paces away from your airplane and still have complete control of all functions. If not, don't attempt to fly! Have your radio equipment checked out by the manufacturer.

Adjusting the Engine (Glow)

Step 1

Completely read the instructions included with your engine and follow the recommended break in procedure.

Step 2

At the field, adjust the engine to a slightly rich setting at full throttle and adjust the idle and low-speed needle so that a consistent idle is achieved.

Step 3

Before you fly, be sure that your engine idles reliably, transitions and runs at all throttle settings. Only when this is achieved should any plane be considered ready for flight.

Maintaining Your Pulse XT ARF

The following is a check list that you should follow every time you have completed a flying session with your Pulse XT. Doing so will keep your aircraft in the best flying condition.

Clean Up

If you are flying with a glow engine you will want to clean your Pulse XT before loading it into your vehicle to head home. Use a cleaner such as Windex or 409 and a paper towel to wipe down the exterior of your plane, removing the fuel residue. Remember a clean plane will last longer since the fuel won't be allowed to soak into any exposed wood. Even an electric may need a little cleaning to remove any grass or bugs from the airframe.

Checking the Propeller

Check to make sure the propeller is tightly secured to the engine. If not, remove the spinner and use a crescent wrench to tighten it back down. If you have had any not-so-great landings, you will want to inspect the propeller for any damage. Small nicks and scratches can quickly become fractures, causing the propeller to be unsafe for flight. Always carry a few spare propellers so a damaged propeller can be replaced at the field, increasing your flying time per trip to the field.

Checking the Clevises

Inspect the aileron, elevator and rudder clevises to make sure they are connected and in good working order. If you find a clevis that is showing signs of wear or is broken, replace it with a new clevis. Also check the nylon connectors at the servo for any wear or damage. If they look worn or in bad shape, replace them as well.

Checking the Control Horns

Inspect the control horns to make sure they have not crushed the wood of the control surface. If so, remove the control horn screws to remove the control horn. Place 2–3 drops of thin CA into each of the screw holes. In addition, use a T-pin to poke small holes in the covering in the area where the control horn mounts, then saturate the area with thin CA. This will harden the wood and give the control horns a solid surface to be mounted to.

Checking the Wheel Collars

Check the setscrews on the main and tail wheel wheel collars to make sure they are not loose. Use a 1.5mm hex wrench to tighten the setscrews. It is suggested if they loosen frequently to remove them, apply threadlock to the setscrews, then secure the wheel collars back into position.

Check the Muffler Bolts

If you are flying with a glow engine, use a 2.5mm hex wrench to make sure the bolts holding the muffler onto the engine are tight and have not vibrated loose during flight.

Check the Engine or Motor Mount Bolts

Remove the spinner and propeller from the engine (or motor) and then remove the cowling from the fuselage. Remove the muffler from the engine (if using a glow engine). Use a Phillips screwdriver and adjustable wrench to make sure the four bolts securing the engine to the mount are tight. Use a Phillips screwdriver to check that the bolts holding the mount to the firewall are tight as well.

Glossary of Terms

- **Ailerons:** Each side of this airplane has a hinged control surface (aileron), located on the trailing edge of the wing. Move the aileron stick on the transmitter left, the left aileron moves up and the right aileron moves down. Moving the left aileron up causes more drag and less lift, causing the left wing to drop down. When the right aileron moves down, more lift is created, causing the right wing to rise. This interaction causes the airplane to turn or roll to the left. Perform the opposite actions, and the airplane will roll to the right..
- **Clevis:** The clevis connects the wire end of the pushrod to the control horn of the control surface. A small clip, the clevis has fine threads so that you can adjust the length of the pushrod.
- **Control Horn:** This arm connects the control surface to the clevis and pushrod.
- **Dihedral:** The degree of angle (V-shaped bend) at which the wings intersect the fuselage is called dihedral. More dihedral gives an airplane more aerodynamic stability. Some sailplanes and trainer planes with large dihedral dispense with ailerons and use only the rudder to control the roll and yaw.
- **Elevator:** The hinged control surface on the back of the stabilizer that moves to control the airplane's pitch axis. Pulling the transmitter's control stick toward the bottom of the transmitter moves the elevator upward, and the airplane begins to climb. Push the control stick forward, and the airplane begins to dive.
- **Fuselage:** The main body of an airplane.
- **Hinge:** Flexible pieces used to connect the control surface to the flying surface. All hinges must be glued properly and securely to prevent the airplane from crashing.
- **Horizontal Stabilizer:** The horizontal flying surface of the tail gives the airplane stability while in flight.
- **Leading Edge:** The front of a flying surface.
- **Main Landing Gear:** The wheel and gear assembly the airplane uses to land. It is attached to the bottom of the fuselage.
- **Pitch Axis:** The horizontal plane on which the airplane's nose is raised or lowered. By moving the elevator, you can raise the airplane's nose above the pitch axis (climb) or lower it below the pitch axis (dive).
- **Pushrod:** The rigid mechanism that transfers movement from the servo to the control surface.
- **Roll Axis:** The horizontal plane on which the airplane's wings are raised or lowered. By adjusting the ailerons, you can drop a wing tip below the roll axis and cause the airplane to bank or roll.
- **Rudder:** The hinged control surface on the vertical stabilizer that controls the airplane's yaw. Moving the rudder to the left causes the airplane to yaw left; moving the rudder to the right causes it to yaw right.
- **Servo:** The servo transforms your transmitter commands into physical adjustments of the airplane.
- **Servo Output Arm:** A removable arm or wheel that connects the servo to the pushrod (also called servo horn).
- **Spinner:** Term describing the nose cone that covers the propeller hub.
- **Threadlock:** A liquid that solidifies; used to prevent screws from loosening due to vibration.
- **Torque Rods:** Inserted into the ailerons, these rigid wire rods run along the wing's trailing edge, then bend downward and connect to the pushrod.
- **Vertical Stabilizer:** The vertical flying surface of the tail gives an airplane stability while in flight.
- **Wheel Collar:** The round retaining piece that anchors wheels in place on the wheel axle.
- **Wing:** The lifting surface of an airplane.
- **Yaw Axis:** The vertical plane through which the airplane's nose rotates as it yaws to the left or to the right. The rudder controls the yaw axis.

2006 Official AMA National Model Aircraft Safety Code

GENERAL

1) I will not fly my model aircraft in sanctioned events, air shows or model flying demonstrations until it has been proven to be airworthy by having been previously, successfully flight tested.

2) I will not fly my model higher than approximately 400 feet within 3 miles of an airport without notifying the airport operator. I will give right-of-way and avoid flying in the proximity of full-scale aircraft. Where necessary, an observer shall be utilized to supervise flying to avoid having models fly in the proximity of full-scale aircraft.

3) Where established, I will abide by the safety rules for the flying site I use, and I will not willfully and deliberately fly my models in a careless, reckless and/or dangerous manner.

4) The maximum takeoff weight of a model is 55 pounds, except models flown under Experimental Aircraft rules.

5) I will not fly my model unless it is identified with my name and address or AMA number, on or in the model. (This does not apply to models while being flown indoors.)

6) I will not operate models with metal-bladed propellers or with gaseous boosts, in which gases other than air enter their internal combustion engine(s); nor will I operate models with extremely hazardous fuels such as those containing tetranitromethane or hydrazine.

7) I will not operate models with pyrotechnics (any device that explodes, burns, or propels a projectile of any kind) including, but not limited to, rockets, explosive bombs dropped from models, smoke bombs, all explosive gases (such as hydrogen-filled balloons), or ground mounted devices launching a projectile. The only exceptions permitted are rockets flown in accordance with the National Model Rocketry Safety Code or those permanently attached (as per JATO use); also those items authorized for Air Show Team use as defined by AST Advisory Committee (document available from AMA HQ). In any case, models using rocket motors as a primary means of propulsion are limited to a maximum weight of 3.3 pounds and a G series motor. (A model aircraft is defined as an aircraft with or without engine, not able to carry a human being.)

8) I will not consume alcoholic beverages prior to, nor during, participation in any model operations.

9) Children under 6 years old are only allowed on the flight line as a pilot or while receiving flight instruction.

RADIO CONTROL

1) I will have completed a successful radio equipment ground range check before the first flight of a new or repaired model.

2) I will not fly my model aircraft in the presence of spectators until I become a qualified flier, unless assisted by an experienced helper.

3) At all flying sites a straight or curved line(s) must be established in front of which all flying takes place with the other side for spectators. Only personnel involved with flying the aircraft are allowed at or in the front of the flight line. Intentional flying behind the flight line is prohibited.

4) I will operate my model using only radio control frequencies currently allowed by the Federal Communications Commission. (Only properly licensed Amateurs are authorized to operate equipment on Amateur Band frequencies.)

2006 Official AMA National Model Aircraft Safety Code

- 5) Flying sites separated by three miles or more are considered safe from site-to site interference, even when both sites use the same frequencies. Any circumstances under three miles separation require a frequency management arrangement, which may be either an allocation of specific frequencies for each site or testing to determine that freedom from interference exists. Allocation plans or interference test reports shall be signed by the parties involved and provided to AMA Headquarters. Documents of agreement and reports may exist between (1) two or more AMA Chartered Clubs, (2) AMA clubs and individual AMA members not associated with AMA Clubs, or (3) two or more individual AMA members.
- 6) For Combat, distance between combat engagement line and spectator line will be 500 feet per cubic inch of engine displacement. (Example: .40 engine = 200 feet.); electric motors will be based on equivalent combustion engine size. Additional safety requirements will be per the RC Combat section of the current Competition Regulations.
- 7) At air shows or model flying demonstrations, a single straight line must be established, one side of which is for flying, with the other side for spectators.
- 8) With the exception of events flown under AMA Competition rules, after launch, except for pilots or helpers being used, no powered model may be flown closer than 25 feet to any person.
- 9) Under no circumstances may a pilot or other person touch a powered model in flight.

Organized RC Racing Event

- 10) An RC racing event, whether or not an AMA Rule Book event, is one in which model aircraft compete in flight over a prescribed course with the objective of finishing the course faster to determine the winner.
 - A. In every organized racing event in which contestants, callers and officials are on the course:
 1. All officials, callers and contestants must properly wear helmets, which are OSHA, DOT, ANSI, SNELL or NOCSAE approved or comparable standard while on the racecourse.
 2. All officials will be off the course except for the starter and their assistant.
 3. "On the course" is defined to mean any area beyond the pilot/staging area where actual flying takes place.
 - B. I will not fly my model aircraft in any organized racing event which does not comply with paragraph A above or which allows models over 20 pounds unless that competition event is AMA sanctioned.
 - C. Distance from the pylon to the nearest spectator (line) will be in accordance with the current Competition Regulations under the RC Pylon Racing section for the specific event pending two or three pylon course layout.
- 11) RC night flying is limited to low-performance models (less than 100 mph). The models must be equipped with a lighting system that clearly defines the aircraft's position in the air at all times.



© 2006 Horizon Hobby, Inc.
4105 Fieldstone Road
Champaign, Illinois 61822
(877) 504-0233
horizonhobby.com