

Name: _____ Date: _____ Event: _____ Track: _____

Track Conditions							
<input type="checkbox"/> Indoor	<input type="checkbox"/> Tight	<input type="checkbox"/> Smooth	<input type="checkbox"/> Hard Packed	<input type="checkbox"/> Blue Groove	<input type="checkbox"/> Wet	<input type="checkbox"/> Low Bite	<input type="checkbox"/> High Bite
<input type="checkbox"/> Outdoor	<input type="checkbox"/> Open	<input type="checkbox"/> Rough	<input type="checkbox"/> Loose/Loamy	<input type="checkbox"/> Dry	<input type="checkbox"/> Dusty	<input type="checkbox"/> Med Bite	<input type="checkbox"/> Other

Front Suspension

Ride Ht	_____
Camber	_____
Toe	_____
Sway Bar	_____
Notes:	_____

- 0mm
- 1mm
- 2mm

- 0mm
- 1mm
- 2mm

- PI
- 17.5
- Al
- 20

- 1mm
- 2mm

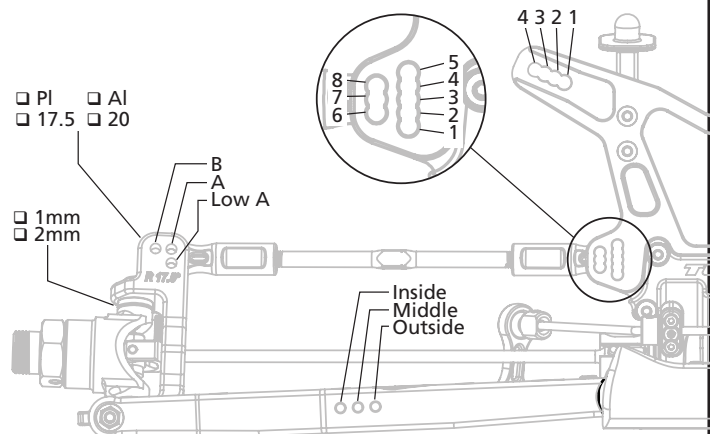
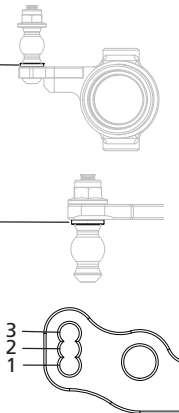
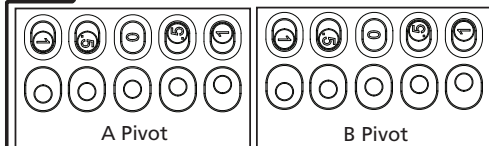

Rear Suspension

Ride Ht	_____
Camber	_____
Sway Bar	_____
Notes:	_____

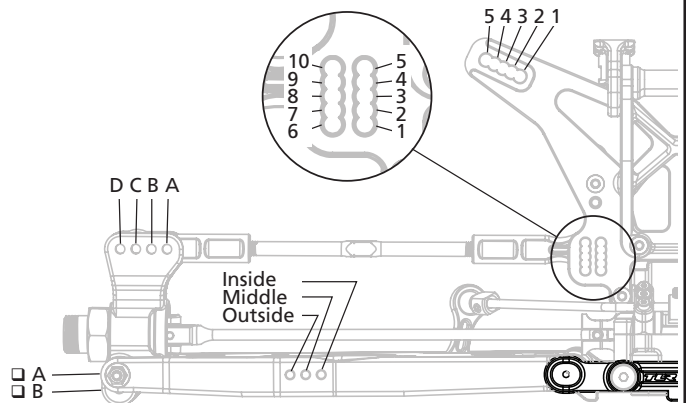
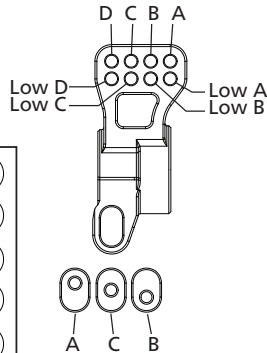
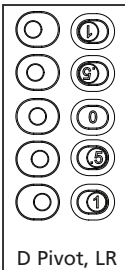

Chassis

Differentials	Front	Center	Rear
Fluid			
Pins	<input type="checkbox"/> AL <input type="checkbox"/> STL	<input type="checkbox"/> AL <input type="checkbox"/> STL	<input type="checkbox"/> AL <input type="checkbox"/> STL
Case	<input type="checkbox"/> STD <input type="checkbox"/> HD	<input type="checkbox"/> STD <input type="checkbox"/> HD	<input type="checkbox"/> STD <input type="checkbox"/> HD

Wing	
Brand	_____
<input type="checkbox"/> Wicker Bill	_____

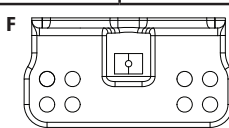

Engine and Clutch			
Engine	_____	Fuel	_____
Glow Plug	_____	Head Clearance	_____
Pipe/Header	_____	Gearing	_____
Clutch Shoes	_____	Clutch Springs	_____
Th Servo	_____	St Servo	_____
Rx Pack	_____	Flywheel	<input type="checkbox"/> AL <input type="checkbox"/> STL

Shocks		
	Front	Rear
Shock Type	<input type="checkbox"/> Bladder <input type="checkbox"/> Re Bladder <input type="checkbox"/> Emulsion <input type="checkbox"/> Vented	<input type="checkbox"/> Bladder <input type="checkbox"/> Re Bladder <input type="checkbox"/> Emulsion <input type="checkbox"/> Vented
Shaft Dia	<input type="checkbox"/> 3.5 <input type="checkbox"/> 4.0	<input type="checkbox"/> 3.5 <input type="checkbox"/> 4.0
Piston	_____	_____
Oil	_____	_____
Spring	_____	_____
Stroke	_____	_____
Droop	_____	_____

Tires		
	Front	Rear
Brand	_____	_____
Tread	_____	_____
Compound	_____	_____
Insert	_____	_____
Sauce	_____	_____

