



# V-Tail

## OPERATING MANUAL



[www.rochobby.com](http://www.rochobby.com)

**Please visit our homepage for updated product information**

## Table of contents

Kit contents.....	1
The spare parts list .....	2
Kit Inspection .....	3
Charging the Flight Battery.....	4
Low Voltage Cutoff .....	5
Assemble the plane .....	6
<b>The control horns installation</b>	
<b>Install the V-shape tail</b>	
<b>Install the main wing</b>	
<b>Disassembly</b>	
<b>Install the battery</b>	
<b>The receiver connection</b>	
<b>The placement of the receiver</b>	
<b>Check the C.G. (Center of Gravity)</b>	
Get your model ready to fly .....	13
<b>Important ESC information</b>	
<b>The model and transmitter setup</b>	
<b>Check the control direction</b>	
<b>Check the control throws</b>	
<b>Check the motor rotating direction</b>	
Before the model flying .....	18
<b>Find a suitable flying site</b>	
<b>Perform the range check of your plane</b>	
<b>Monitor your flight time</b>	
Flying course .....	19
<b>Take off</b>	
<b>Flying</b>	
<b>Landing</b>	
<b>Maintenance</b>	
Troubleshooting .....	20
AMA .....	21

# WARNING

 **WARNING:** Read the ENTIRE instruction manual to become familiar with the features of the product before operating. Failure to operate the product correctly can result in damage to the product, personal property and cause serious injury.

This is a sophisticated hobby product and NOT a toy. It must be operated with caution and common sense and requires some basic mechanical ability. Failure to operate this Product in a safe and responsible manner could result in injury or damage to the product or other property. This product is not intended for use by children without direct adult supervision.

This manual contains instructions for safety, operation and maintenance. It is essential to read and follow all the instructions and warnings in manual, prior to assembly, setup or use, in order to operate correctly and avoid damage or serious injury.

## Safety Precautions and Warnings

As the user of this product, you are solely responsible for operating in a manner that does not endanger yourself and others or result in damage to the product or the property of others. This model is controlled by a radio signal subject to interference from many sources outside your control. This interference can cause momentary loss of control so it is advisable to always keep a safe distance in all directions around your model, as this margin will help avoid collisions or injury.

Age Recommendation: Not for children under 14 years. This is not a toy.

- Never operate your model with low transmitter batteries.
- Always operate your model in an open area away from cars, traffic or people.
- Avoid operating your model in the street where injury or damage can occur.
- Never operate the model in the street or in populated areas for any reason.
- Carefully follow the directions and warnings for this and any optional support equipment (chargers, rechargeable battery packs, etc.) you use.
- Keep all chemicals, small parts and anything electrical out of the reach of children.
- Moisture causes damage to electronics. Avoid water exposure to all equipment not specifically designed and protected for this purpose.
- Never lick or place any portion of your model in your mouth as it could cause serious injury or even death.

## **ROCHOBBY Friendly Reminder**



Thank you for purchasing a RocHobby product. Our goal is to provide high quality products and offer great customer service. If you have any problems with your product or want to offer suggestions for improvements (such as plane design, packaging, building instructions, etc.) please feel free to contact us at [info@rochobby.com](mailto:info@rochobby.com)

**Kit contents**

1. The fuselage (Front gear, motor, ESC, propeller, spinner, canopy, motor hatch cover, )
2. Main wing set (A set of main wings with the flap and aileron control servos installed)
3. V shape tail (The tail with the servos)
4. Battery (RTF Version Only)
5. 2-3 cells BC-3C10 balance charger (RTF Version Only)

## The spare parts list

Replacement parts for the ROC Hobby V-tail are available using the order numbers in the Spare parts list that follows. The fastest, most economical service can be provided by your hobby dealer or mail-order company.

### Spare parts list content

- KD 101 Fuselage (With the motor board and extension wire installed)
- KD 102 Main wing set (With all the plastic part installed)
- KD 103 Canopy
- KD 104 V-tail
- KD 105 Propeller set (Propeller and the spinner)
- KD 106 Main wing securing bolt (Two pieces with different length)
- KD 107 Tail locking plate
- KD 108 Motor mount (With two pieces machine screws)
- KD 109 Linkage rod (With the clevis and securing ring)
- KD 110 Battery (11.1V 1300mAh 25C )
- KD 111 Motor (4018 KV900)
- KD 112 ESC (35A)
- KD 113 Servo (9g positive)
- KD 114 Decal sheet

### The illustration of the spare parts



KD-101



KD-102



KD-103



KB-104



KD-105

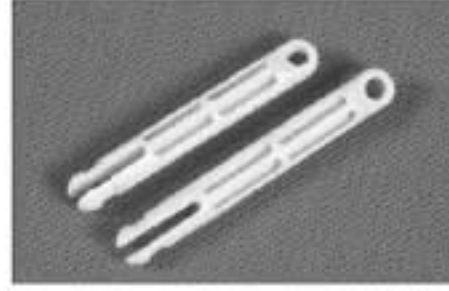

KD-106



KD-107



KD-108

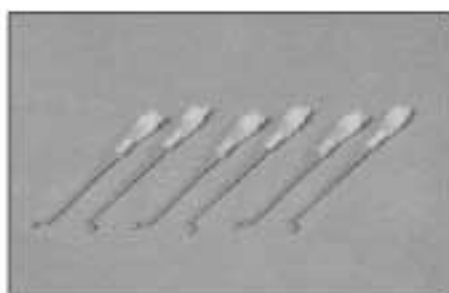

KD-109



KD-110



KD-111

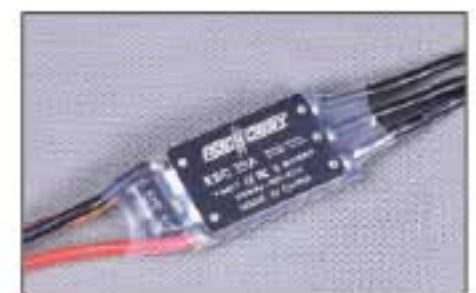

KD-112



KD-113



KD-114

## Kit inspection

Before starting to build, inspect the parts to make sure they are acceptable quality. If any parts are missing or are not in good shape or acceptable quality, or if you need assistance with setup and assembly, please feel free to contact ROC TEAM. Please write down the name of the parts when you are reporting defective or missing of them.

ROC TEAM Product Support

ADDRESS: **Weijian 2nd Road, Area39, Chashan Industrial Park, Chashan Town, Dongguan City, China**

Tel: **86-0769-86976658**

Email: **info@rochobby.com**

Web: **www.rochobby.com**

## Charging the Flight Battery

The Battery Charger included with your aircraft is designed to safely charge the Li-Po battery, **Caution:** All instructions and warnings must be followed exactly. Mishandling of Li-Po batteries can result in fire, personal injury, or property damage.

### **Battery warning:**

By handling, charging or using the included Li-Po battery you assume all risks associated with lithium batteries.

If at any time the batteries begin to swell, or balloon, discontinue use immediately!

Charging or discharging a swelling or ballooning battery can result in fire.

Always store the batteries at room temperature in a dry area to extend the life of the battery. Always transport or temporarily store the battery in a temperature range of 40-120°F. Do not store battery or model in a car or in direct sunlight. If stored in a hot car, the battery can be damaged or even catch fire.

Never use a Ni-Mh charger. Failure to charge the battery with a compatible charger may cause fire resulting in personal injury and property damage.

Never discharge Li-Po cells to below 3V.

Never leave charging batteries unattended.

Never charge damaged batteries.

### **Charging the flight battery**

RTF kits come with a DC balancing charger. You must charge the battery with a Li-Po specific charger only (such as the included **BC-3S10** DC charger). When charging the battery, make certain the battery is on a heat-resistant surface, charge the battery before assembly of the airplane. Install the fully charged battery to perform control tests and binding.

### **BC-3S10** Balance Charger

To correctly use the charger, please read the instructions before use.

## Charging the Flight Battery

### Electrical Parameters

Parameter	Min	Type	Max	Unit
Working Voltage	9	12	16	V
Input Power	15			W
Work Temperature	- 20		45	°C
Store Temperature	- 20		65	°C
Charging Stop Voltage	4 . 19	4 . 20	4 . 21	V
Charging Current			1000	mA
Balancing Current	150		200	mA
Activate Current	80		120	mA

#### Using Steps:

1. Connect the charger to adapter with enough voltage and wattage, then the Power LED will turn on;
2. Connect 2S/3S battery pack to the corresponding balance port (**Do not connect two battery packs at the same time**), then the Charge LED will flicker (1Hz) and start charging.
3. When the Charge LED stops flickering, charging is complete, and the batteries can be unplugged.

#### Charging Function Description

1. If all voltage of the installed battery pack is higher than 4.18V, charging will not start and the charge LED will shine.
2. If the voltage of one battery or some batteries is lower than 0.7V, charging will not start. If the voltage of the first battery of a 3S battery pack is lower than 0.7V, the charger will charge the battery pack as if it was a 2S battery pack.
3. If the voltage of one battery or some batteries is lower than 2.8V, the charger will activate the battery pack with a small current. If the voltage can't be increased above 2.8V after half an hour, the charger will judge the battery pack as bad. The charge LED will then flicker rapidly (0.5Hz), and charging will stop.

#### Self Checking Function

1. Charger will perform a self test before each charge. The charge LED will rapidly flicker (0.5Hz) if the charging function is abnormal;
2. Accuracy checking Function: Connect a fully charged 3S battery pack (all voltage at least 4.2V), the charge LED will flicker twice then shine always. This means that the accuracy is normal.

## Charging the Flight Battery

### **Protection Function**

1. Reverse connection protection of input
2. Reverse connection protection of output
3. Short circuit protection of output
4. Over voltage protection of output

### **Troubleshooting**

1. **Power LED does not shine** – Adapter isn't connected correctly. Please check the polarity and reconnect adapter.
2. **Charging abruptly stops and tries to restart constantly during charging** – Output power of the adapter is not sufficient, please replace the adapter.
3. **Charge LED does not shine** – Reconnect the battery pack; Check the voltage of batteries.
4. **Charge LED rapidly flickers** – Battery is bad or charging function is abnormal. Replace battery or contact technical support.

## Low voltage cut off (LVC)

When a Li-Po is discharged below 3V per cell, it will not hold a charge. The ESC protects the flight battery from over-discharge using Low Voltage Cutoff. Before the battery charge decreases too much, LVC removes power from motor in two ways: (1) Reduces power - ESC reduces motor power (recommended), (2) Hard cutoff - ESC instantly cuts motor power when the pre-set Low Voltage Protection Threshold value is reached. These settings can be changed using the ESC programming guide (available on-line).



## Assemble the plane

### The control horns installation

1. The control horns and linkage rods are packed separately and contained in the spare parts bag.



2. Install the Aileron horns. Fit the horn into the pre-notched slot on the bottom side of the aileron. Orient the horn as shown in Fig 2.



3. Place the backplate on the opposite side with the small protruding collars facing into the aileron's surface.



4. Secure the control horn from the horn mounting side using the provided screws. The parts bag contains short and long screws. Be sure to use the shorter screws in the hole closest to the trailing edge side of the aileron (do the same for flaps and v-tails) and the longer screws in the holes closest to the servos.

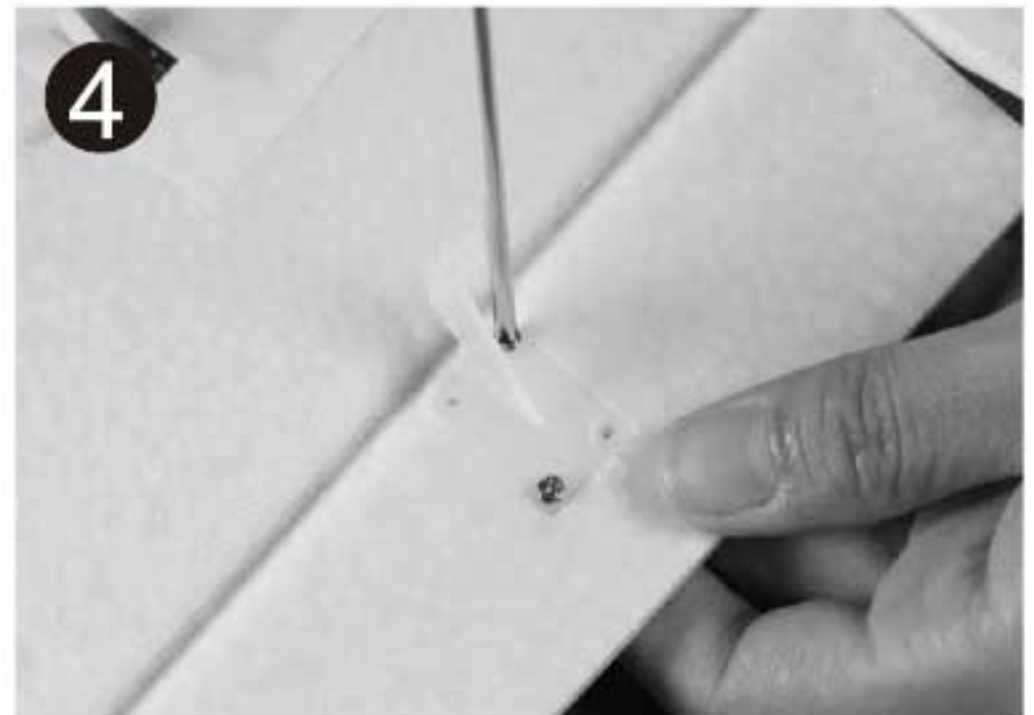

5. Repeat steps 2, 3, 4 for the flap control horns installation.

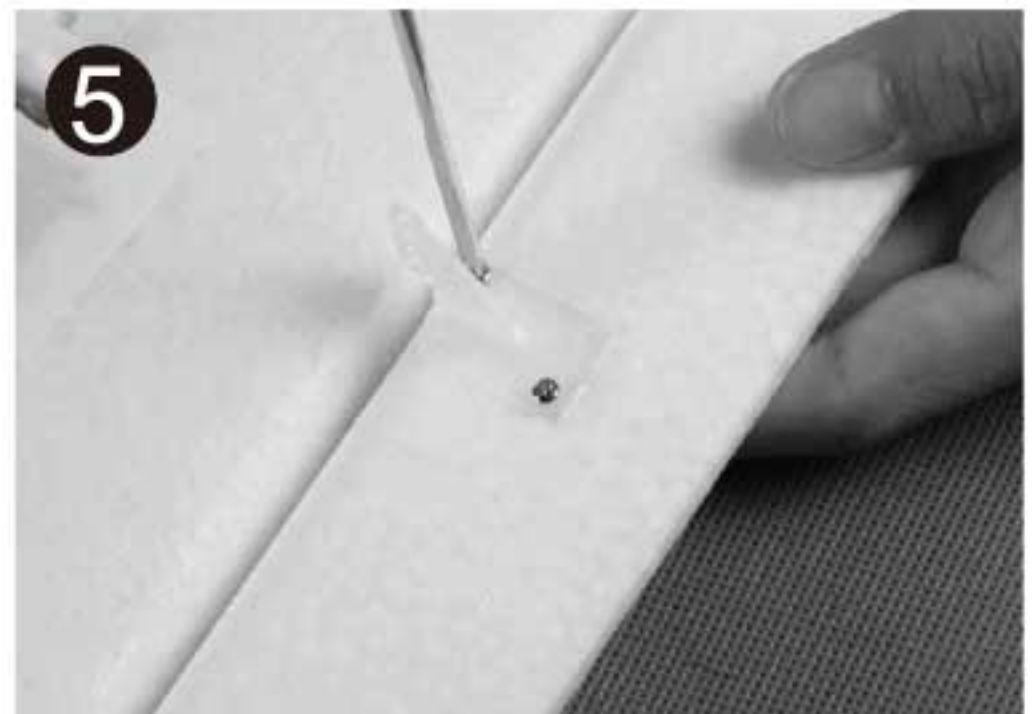

6. Install the v-shape tail horn using the same method as the ailerons. The control horns should be located on the same side as the decal.

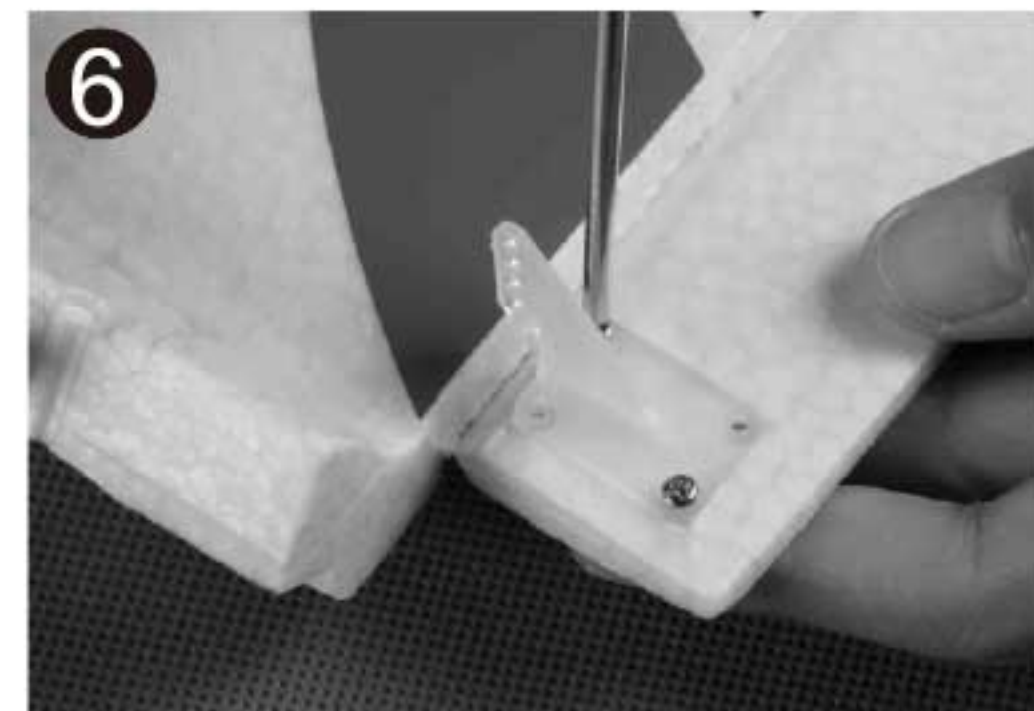

## Assemble the plane

1. Insert the two white reinforcement bars into the tail half.

**Note:** Do not force it further than it will slide, but make sure they get through the plastic mount.



2. Connect the halves together. Check to make sure the reinforcement bars do not protrude out of the foam on either side of the tail halves.



3. Fix the leads of the tail control servos with the tape as shown in the picture.

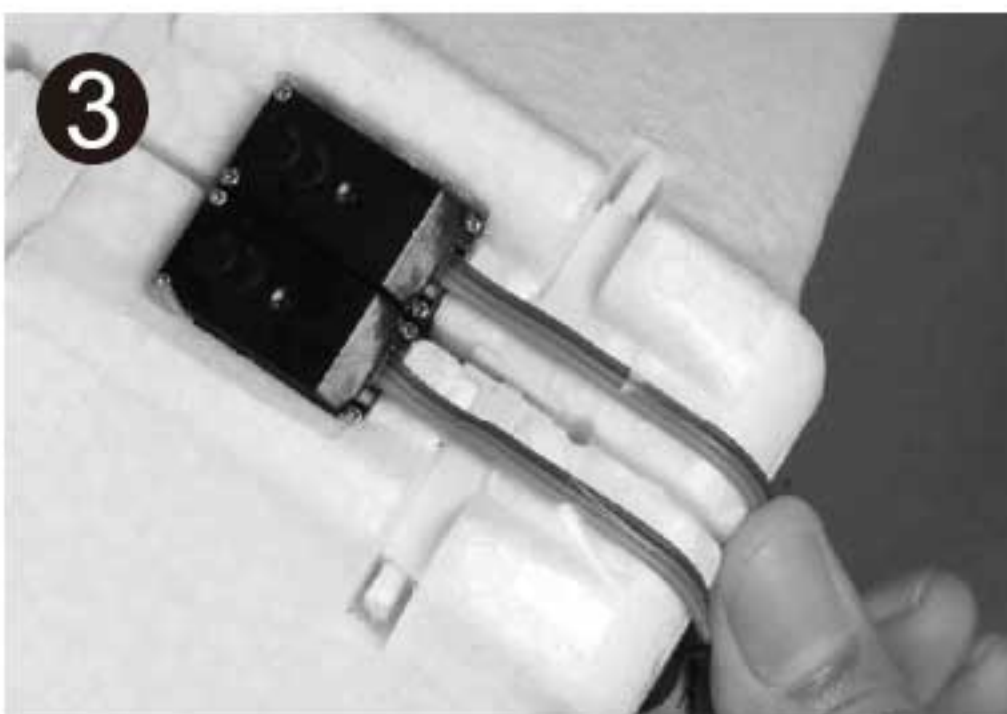

### Install the V-shape tail

4. Connect the tail servo wires to the servo wire extensions in the rear of the fuselage. Make sure to match the numbered labels and also check that the orange and/or white colored wires match when connected.

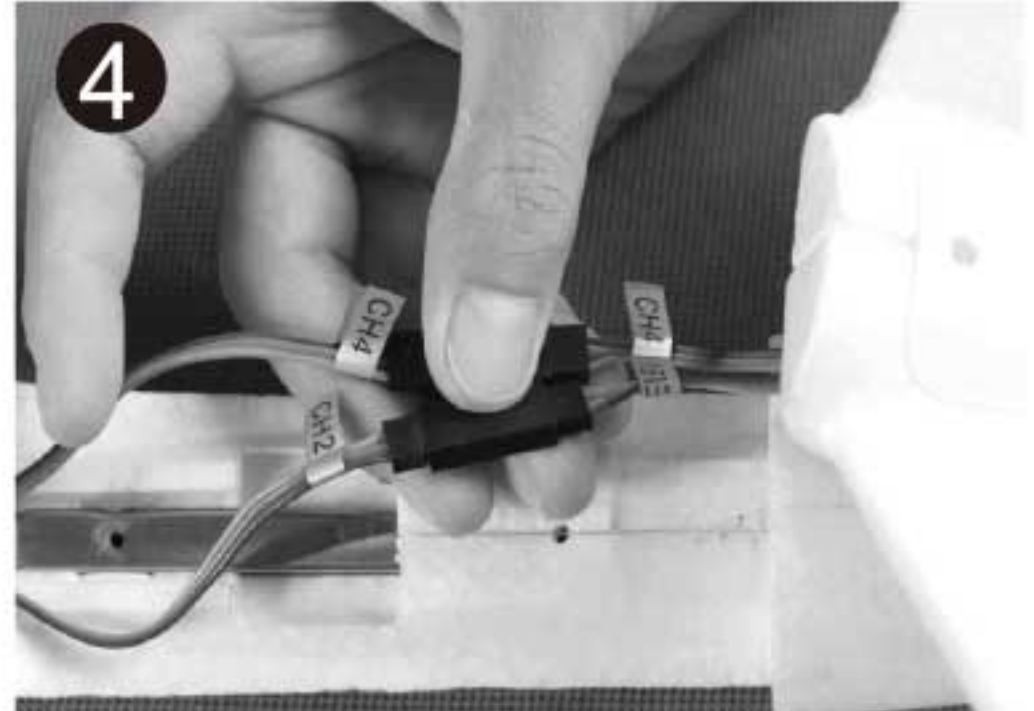

5. Secure the plug with the tape to prevent the wires from coming loose in flight.

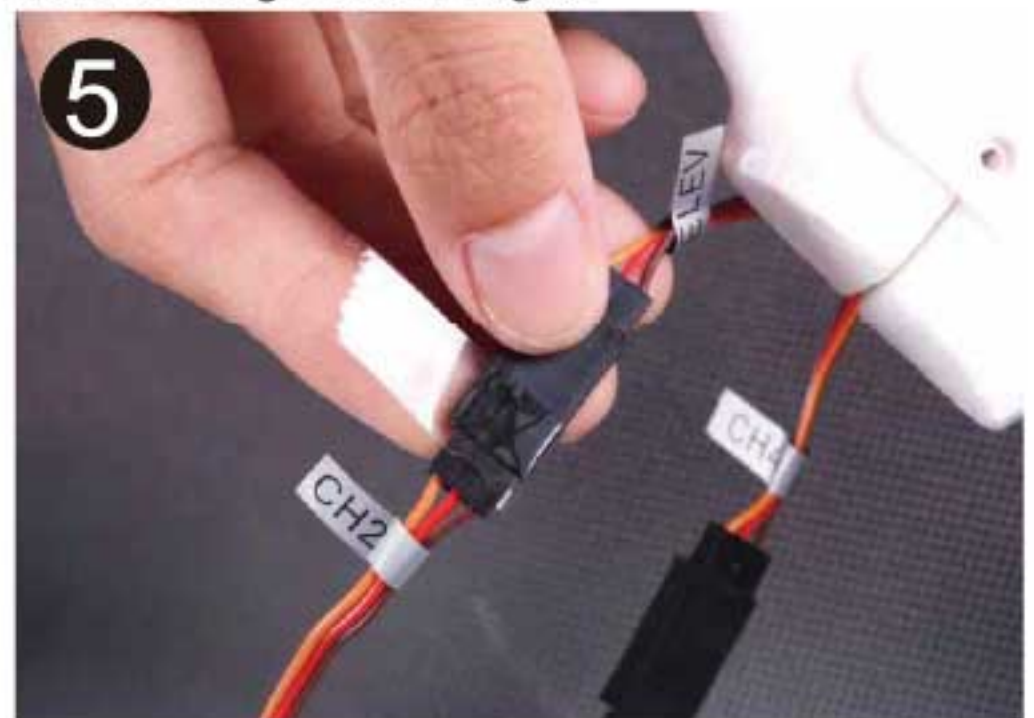

6. Mount the tail by seating the connector into the hole in front of the tail mounting bay. Pull the extension wires from the power system hatch side and seat the tail fully into place.



## Assemble the plane

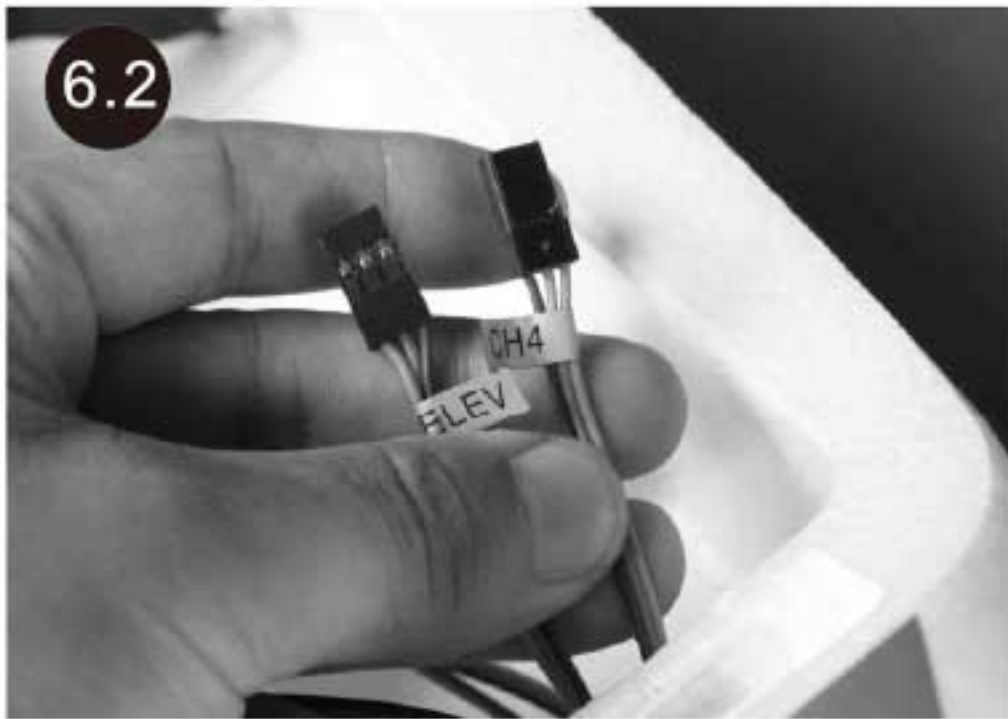

7. Secure the tail into place using the provided tail securing plate. Make sure the plate aligns with both servos so that the tops of each servo fits in the cutout of the securing plate.  
(Screws PA 2.6\*35 2PCS)



## Install the main wing

1. The servo wire Y-harness for flaps and ailerons are pre-installed in the fuselage. One end of the harness should stick out from the wing mounting saddle, and the other end should be located in radio / battery compartment.



2. Connect the servo leads from the wing with the extension wires in the fuselage. Use the labels on the servo leads to match all four servos.

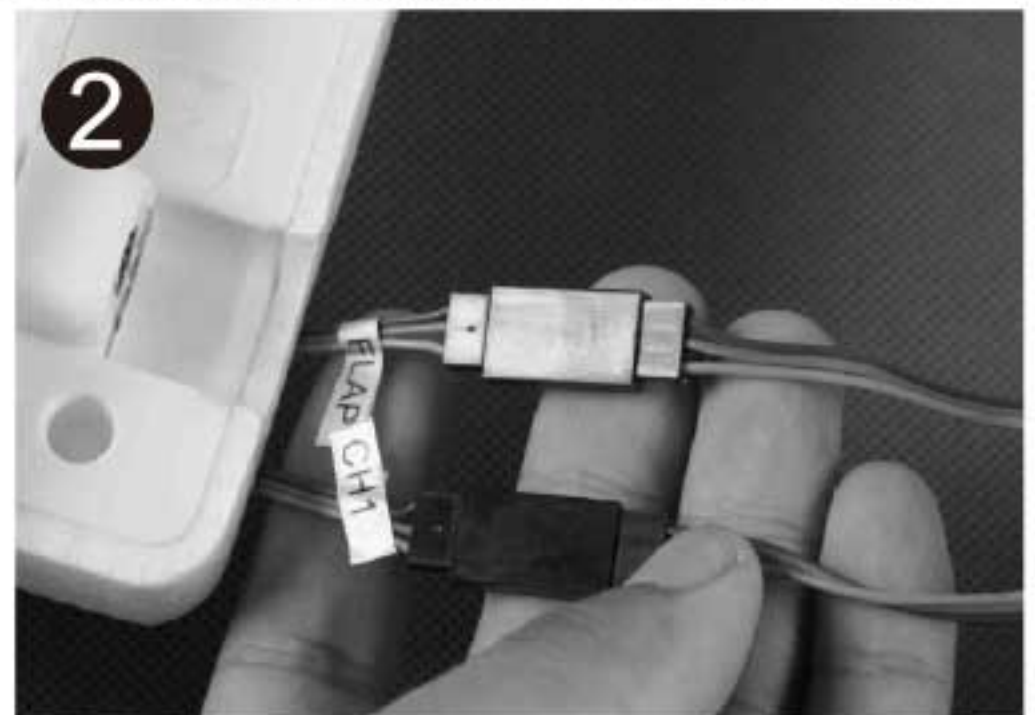

3. Secure all the four plugs using tape.



## Assemble the plane

4. Insert the aluminum wing spar into the main wing panel until the white retainer ring touches the wing.

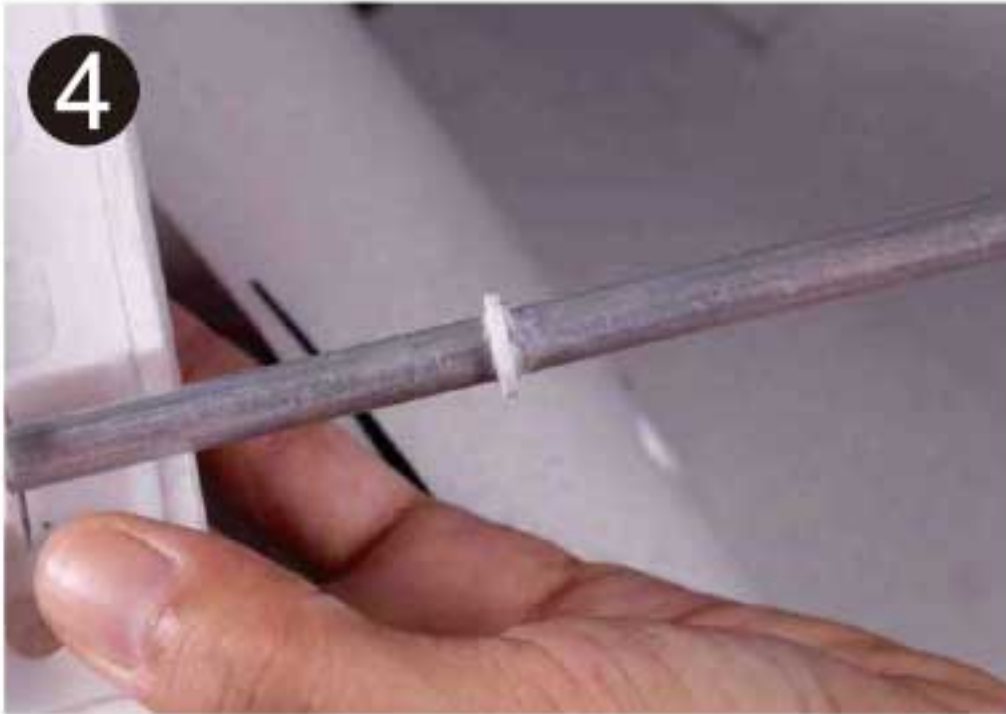

5. Mount the main wing into the wing saddle. You will need assistance to help pull the leads from the battery compartment side so that the wires do not interfere with the wing seating fully into place.



6. Check to make sure the two wing halves are fully seated into place.



7. Snap in the main wing securing bolts. Note that the bolts are different sizes. The longer bolt should be installed in the hole closest to the front of the airplane.

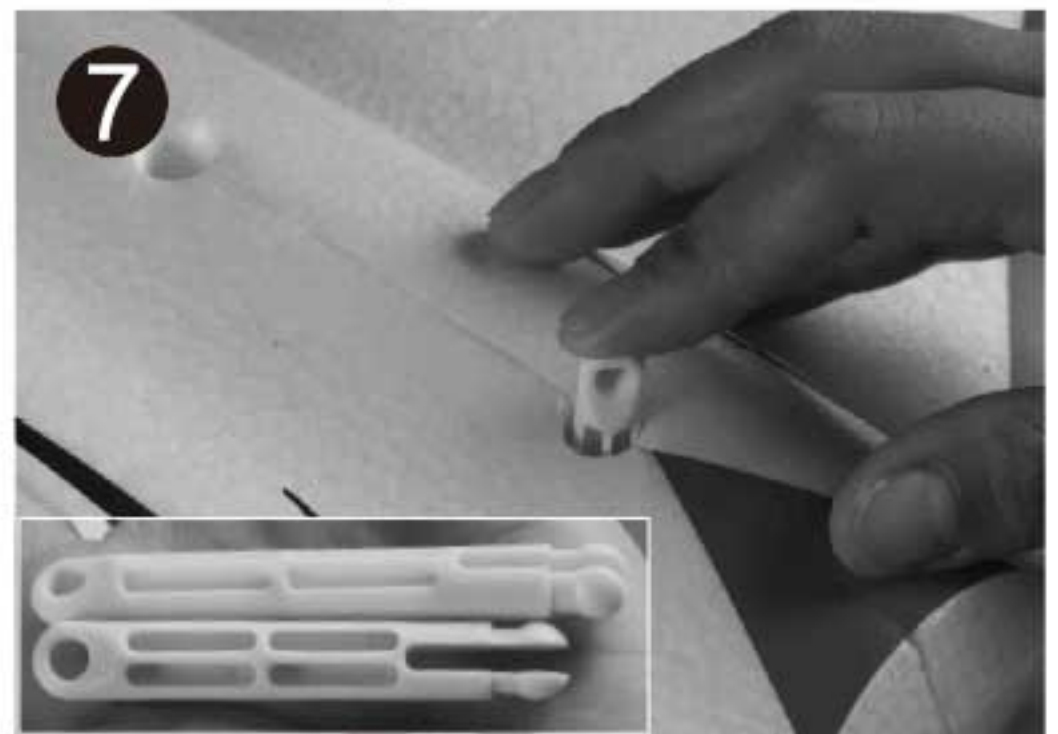

8. The bolts can be removed later by using a screwdriver or similar tool.

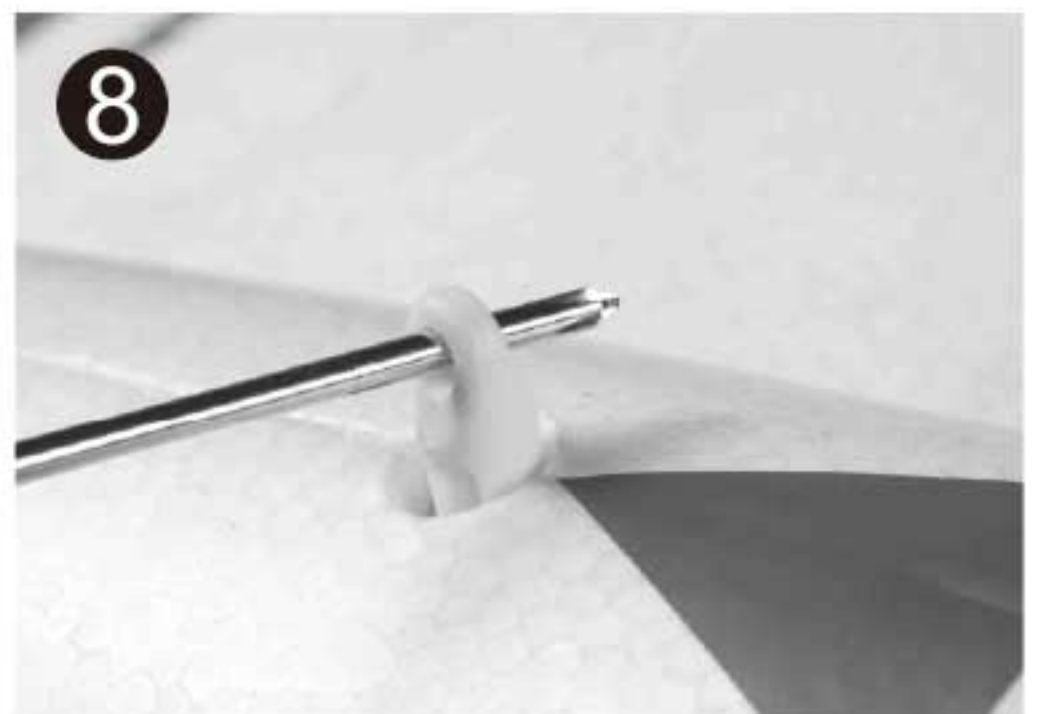

## Assemble the plane

### Disassembly

1. The spinner is snapped into the propeller backplate. To remove, hold the spinner near the root of the propeller and squeeze gently.



2. Remove the nut using a nose needle plier or a socket wrench while holding the propeller set into place.



3. Remove the propeller set from the motor shaft.



4. Always check that the foldaway propeller blades are attached properly. Make sure that the bolts are on completely, but not too tight or they will prevent the blades from spinning freely.



## Assemble the plane

### Install the battery

1. Slide the battery into the hook and loop ring from the back of the battery compartment with the cable toward the rear side of the hatch.

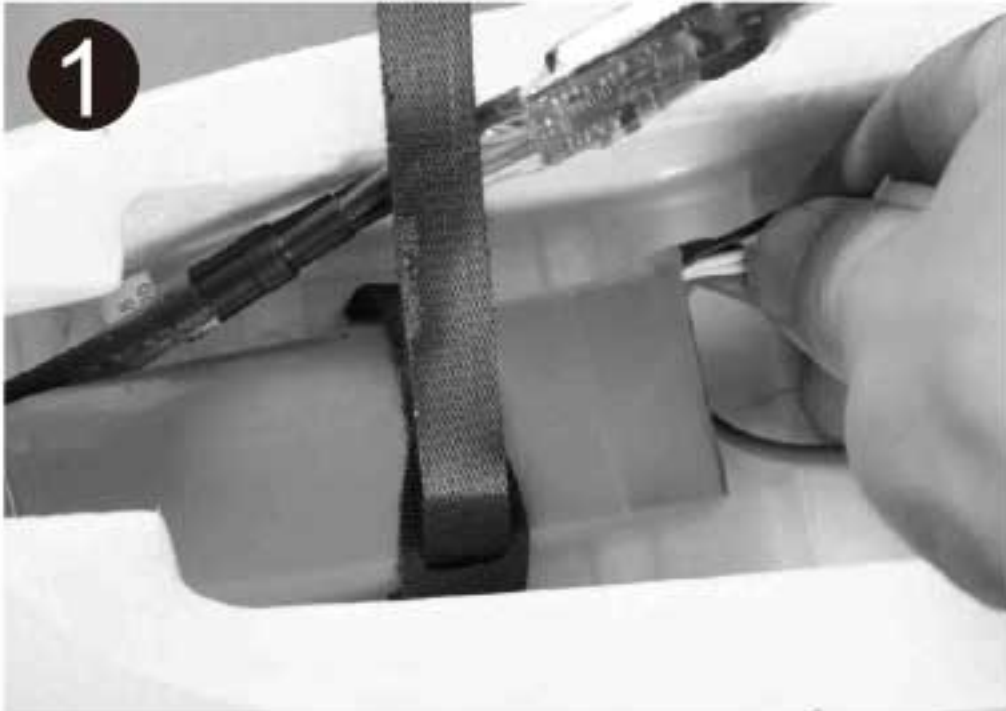

2. Secure the battery into place using the hook strip.

**Note:** Do not arm the ESC while placing the battery into the compartment.

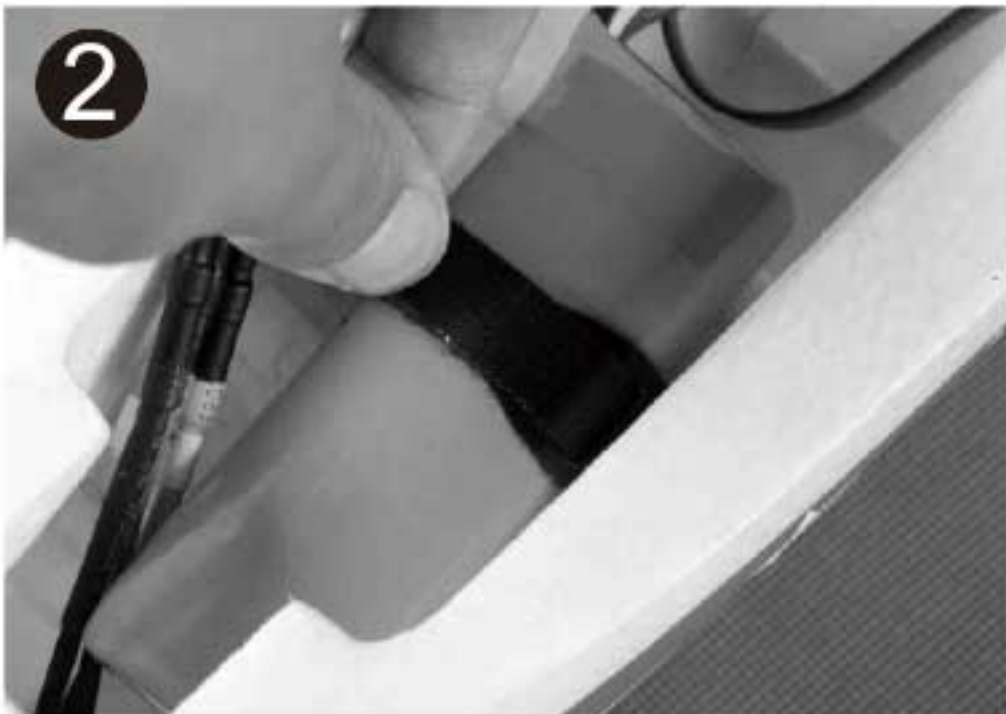

### The receiver connection

Attach right v-tail to the elevator channel of your receiver. The left v-tail goes to the rudder channel of your receiver. You will need to activate the V-tail configuration of your transmitter. Attach the ESC connector to the throttle channel of the receiver.

		Receiver
Aileron	1	Channel-1 — Aile
Elevator	2	Channel-2 — Elev
Throttle	3	Channel-3 — Thro
Rudder	4	Channel-4 — Rudd
Flaps	5	Channel-5 — Flaps

### The placement of the receiver

1. Place the receiver in the fuselage cavity on the rear end of the canopy hatch.



## Assemble the plane

### Check the C.G. (Center of Gravity)

#### Center of Gravity

When balancing your model, adjust the battery as necessary so that the model is level or slightly nose down. This is the correct balance point for your model. After the first few flights, the **CG** position can be adjusted for your personal preference.

1. The recommended Center of Gravity (**CG**) location for your model is (75mm/3 in) back from the leading edge of the main wing with the battery installed, as shown below.

Mark the location of the **CG** on the top of the wing.

2. When balancing your model, support the plane inverted at the marks made on the top of the main wing with your fingers or a commercially available balancing stand. This is the correct balance point for your model, Make sure the model is assembled and ready for flight before balancing.



### Important ESC information

1. The ESC included with the V-tail has a safe start. If the motor battery is connected to the ESC and the throttle stick is not in the low throttle or off position, the motor will not start until the throttle stick is moved to the low throttle or off position. Once the throttle stick is moved to the low throttle or off position, the motor will emit a series of beeps. Several beeps with the same tune means the ESC has detected the cells of the battery. The counts of the beeps equals the cells of the battery. The motor is now armed and will start when the throttle is moved.
2. The motor and ESC come pre-installed and the motor rotation should be correct. If you disconnect the ESC from the motor, be sure to reverse two of the three motor wires when you reconnect it. This will ensure proper motor rotation.
3. The motor has an optional brake setting. The ESC comes with the brake switched ON and we recommended that the V-tail be flown with the brake on. However, the brake could be accidentally switched off if the motor battery is connected to the ESC while the throttle stick is set at full throttle. To switch the brake on, move the throttle stick to full throttle and plug in the motor battery. The motor will beep **one time**. Move the throttle stick to low throttle or the off position. The motor is ready to run and the brake will be switched on.
4. Battery Selection and Installation. We recommend an 11.1V 1300mAh 25C Li-Po battery be used with the V-Tail glider. If using another battery, the battery must be at least a 11.1V 1300mAh 25C battery. Your battery should be approximately the same capacity, dimension and weight as the 11.1V 1300mAh 25C Li-Po battery to fit in the fuselage without changing the center of gravity.



## Get your model ready to fly

### The model and transmitter setup

Before getting started, bind your receiver with your transmitter. Please refer to your **Transmitter Manual** for proper operation.

**CAUTION:** To prevent personal injury, DO NOT install the propeller assembly onto the motor shaft while testing the control surfaces. DO NOT arm the ESC and do not turn on the transmitter till the **Transmitter Manual** instructs you to do so.

**Tips:** V-shape tails are controlled by elevator and rudder mixing (Moveable surfaces on the tails). Take the elevator control (moves in the same direction), and ruder control (moves in the left/right direction) and mix them together electronically through the transmitter. Make sure all control sticks on your radio are in the neutral position (rudder, elevator, ailerons) and the throttle in the OFF position. Make sure both aileron move up and down (travel) the same amount. This model tracks well when the left and right ailerons travel the same amount in response to the control stick.

1. Fly the model at factory setting before making the connection changes. For pilots who wish to fly model with unlimited aerobatics, adjust position of linkages on servo arms and control horns for increased travel. For standard flight, connect all the linkages to the holes shown in figure 1.

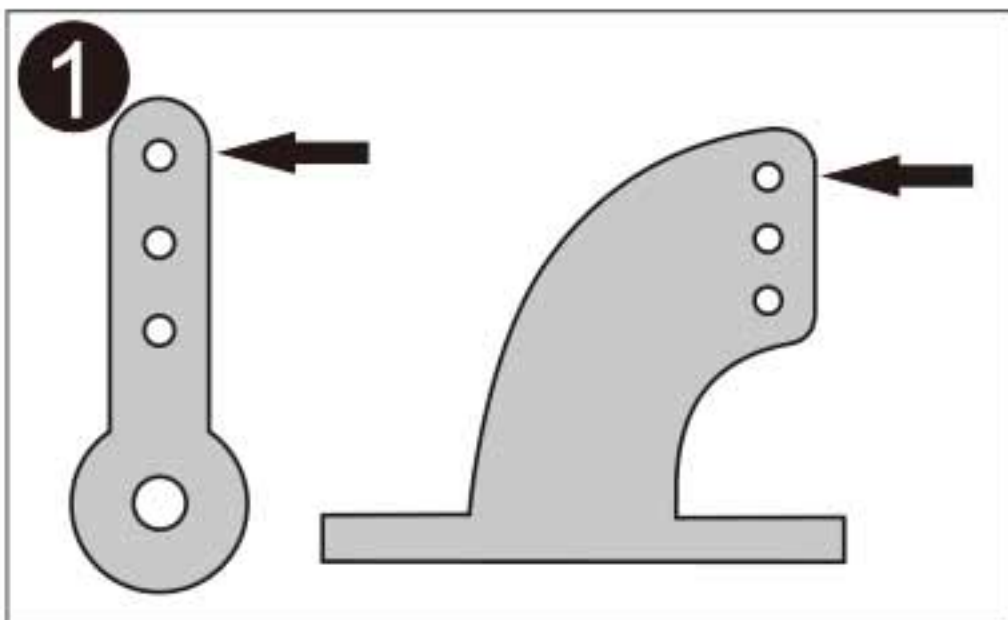

2. Turn on the transmitter, enable the v-tail function, and arm the ESC. Install the two servo control arms making sure they are perpendicular with the centerline of the fuselage.

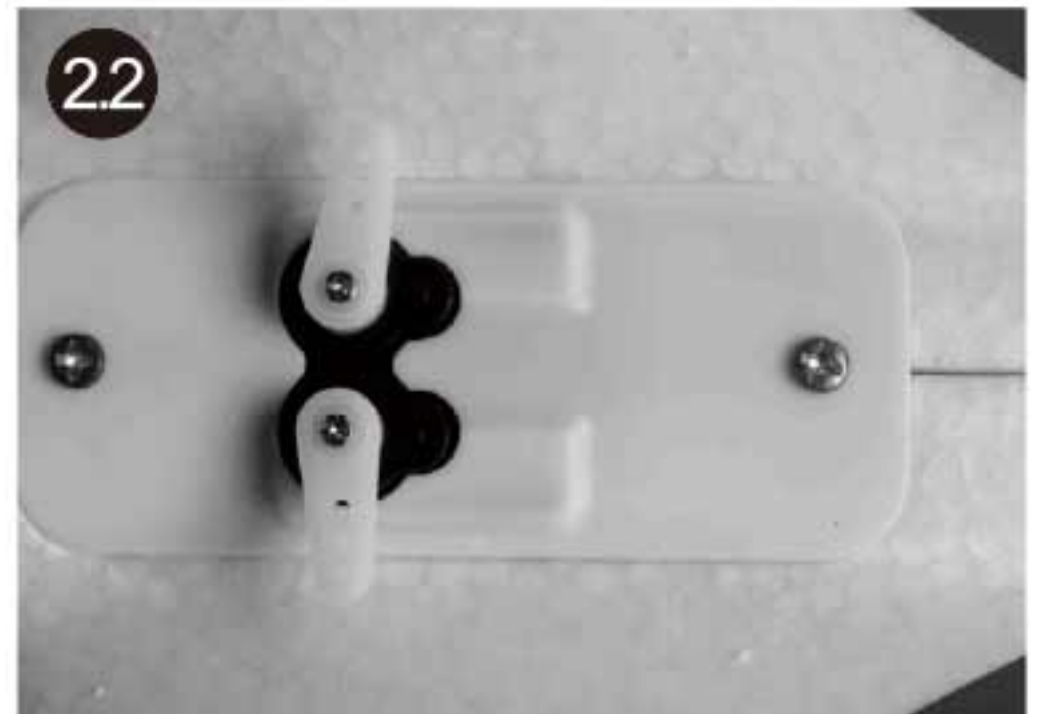

3. Put the Z-bend end of the linkage into the desired servo control horn hole of the v-tail. It is a tight fit and should allow the linkage to move just slightly within the hole to avoid binding up.



## Get your model ready to fly

4. Align the control surface with the wing root by turning the clevis clockwise or counterclockwise on the linkage. Carefully open the clevis fork and put the clevis pin in the desired hole of the control horn. Snap the clevis closed.

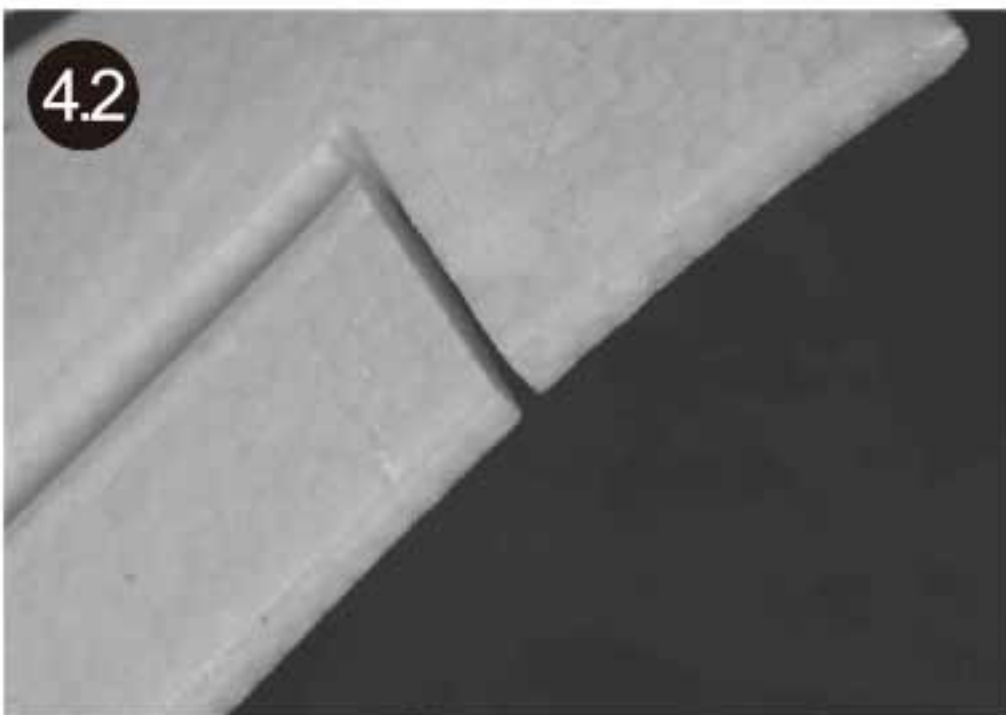
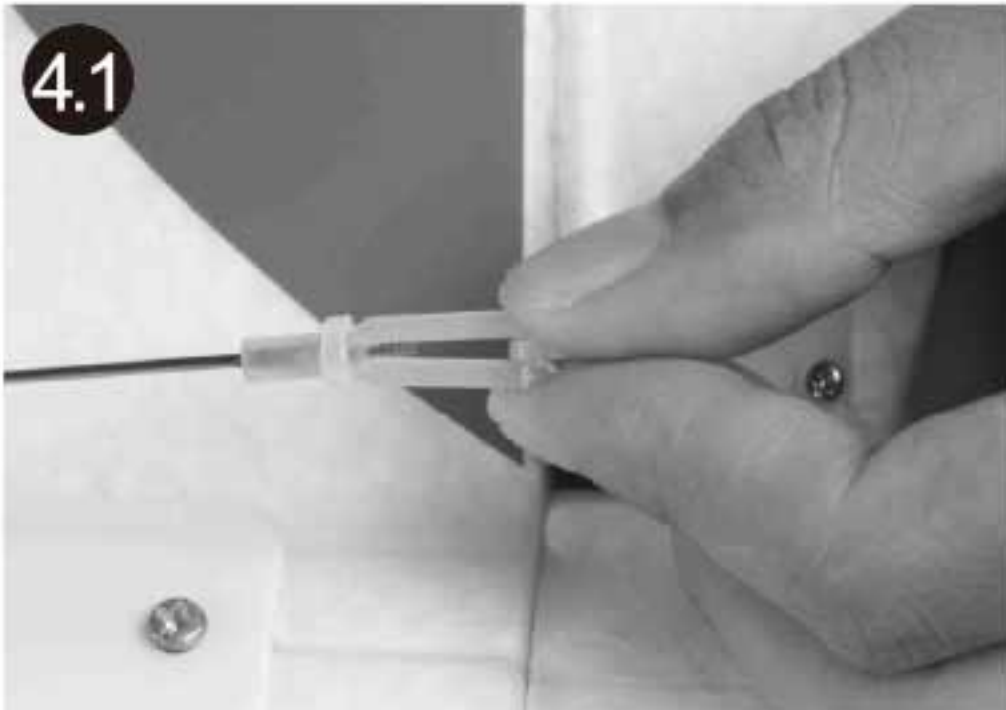

5. The provided piece of fuel tubing keeps the clevis closed during flight.  
**Note:** Do not slide the tubing too far towards the control horn or it may impede the movement of the control surface.

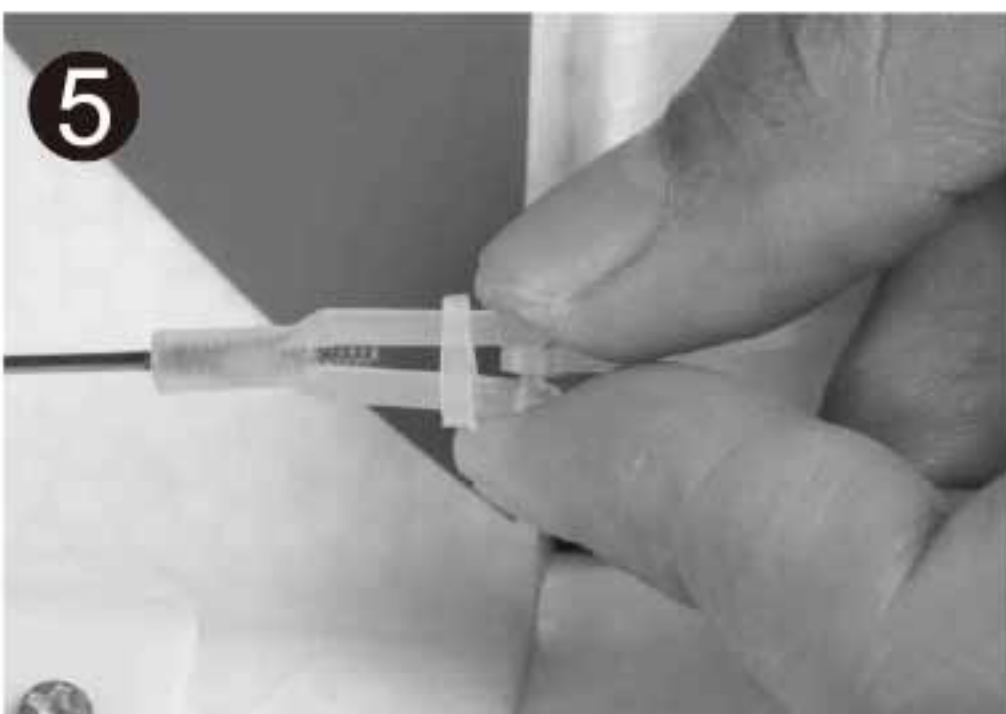

6. Repeat the same steps 3, 4, 5 for the ailerons and flaps linkage rod installation. Make sure the flaps can move freely from up position to the down position (landing position).

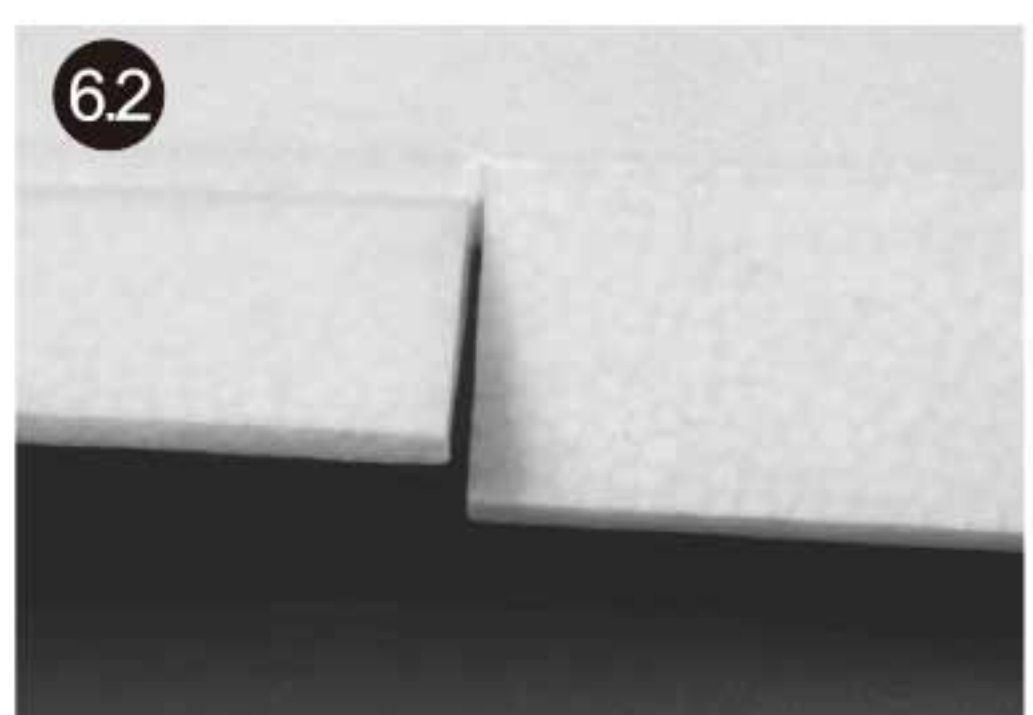
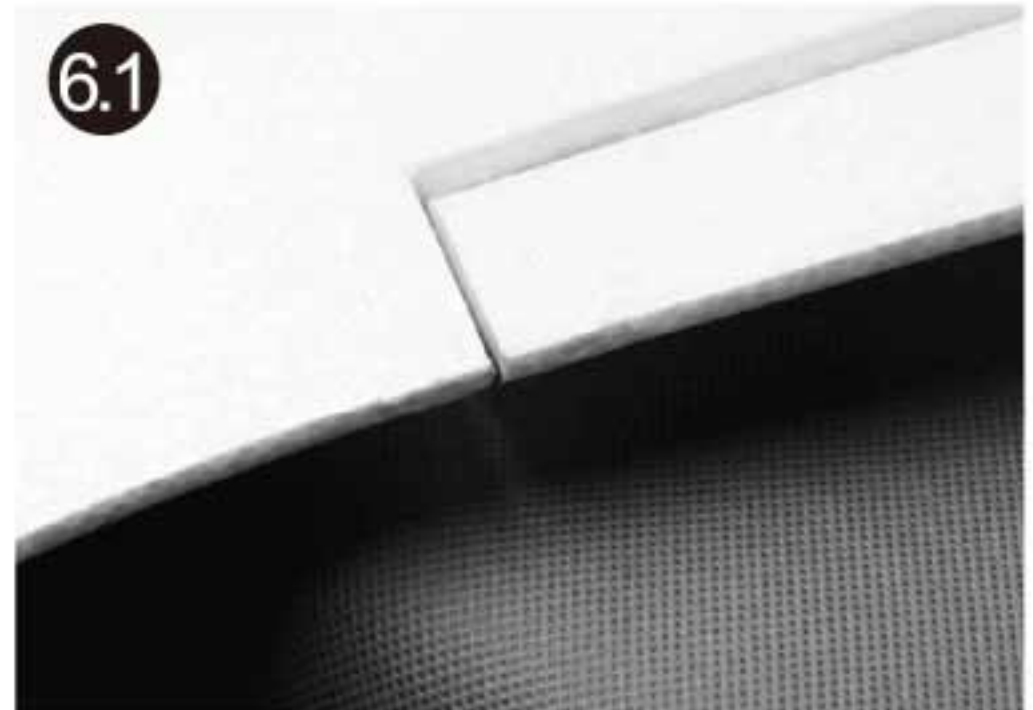

## Get your model ready to fly

### Check the control direction

Move the controls on the transmitter to make sure aircraft control surface move correctly. Disconnect one of the motor power supply wire before arming the ESC to avoid any injury. The control surface direction testing is shown below from the tail view of the plane.

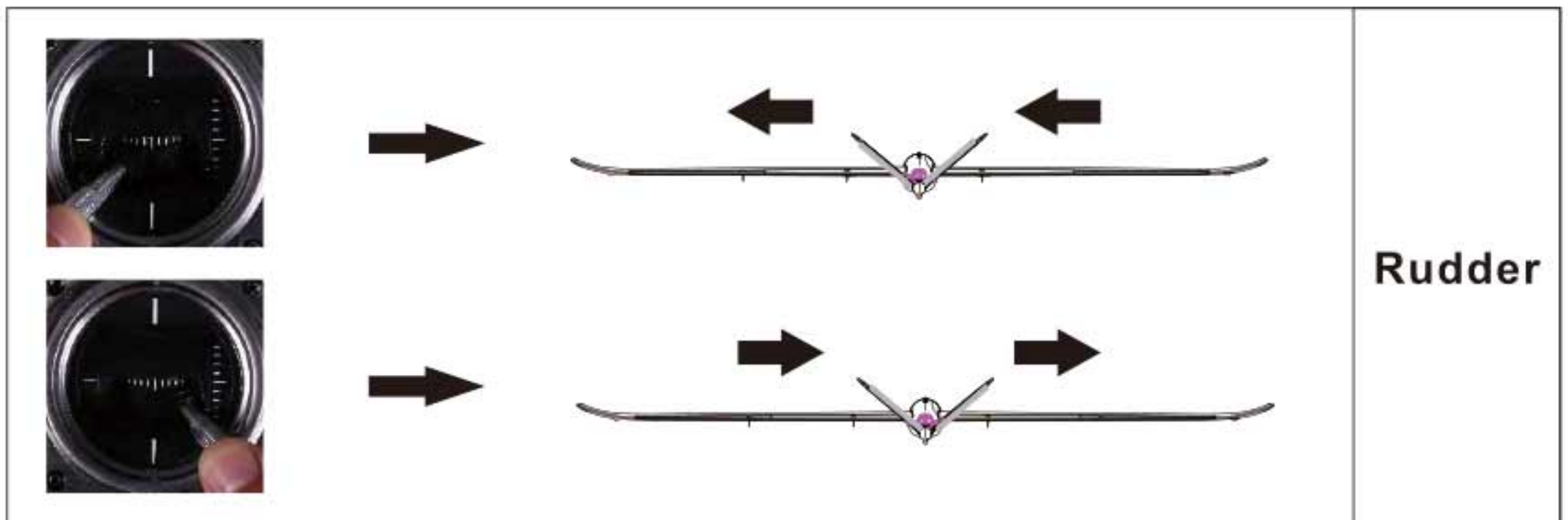
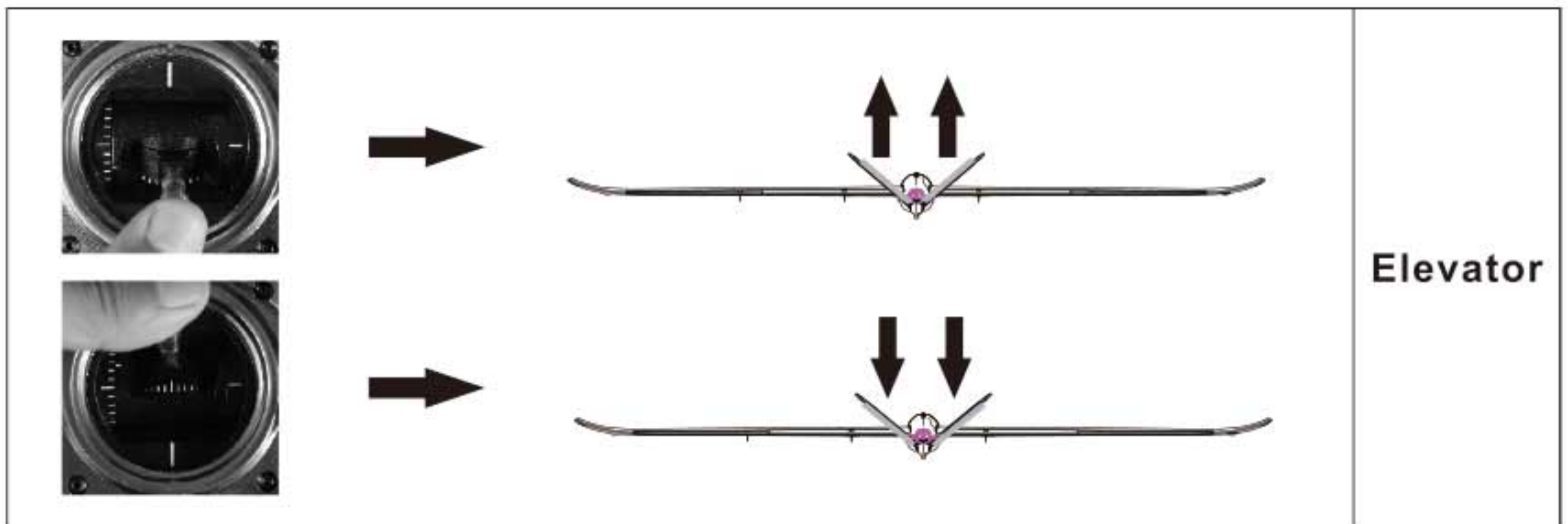
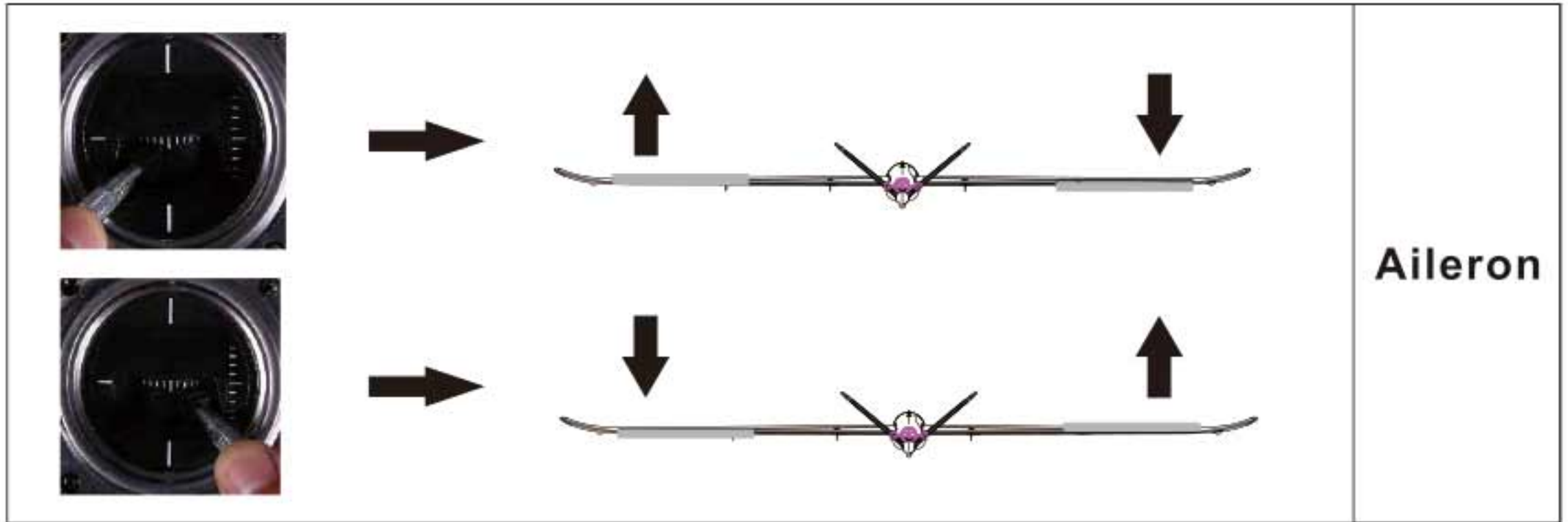

Get your model ready to fly

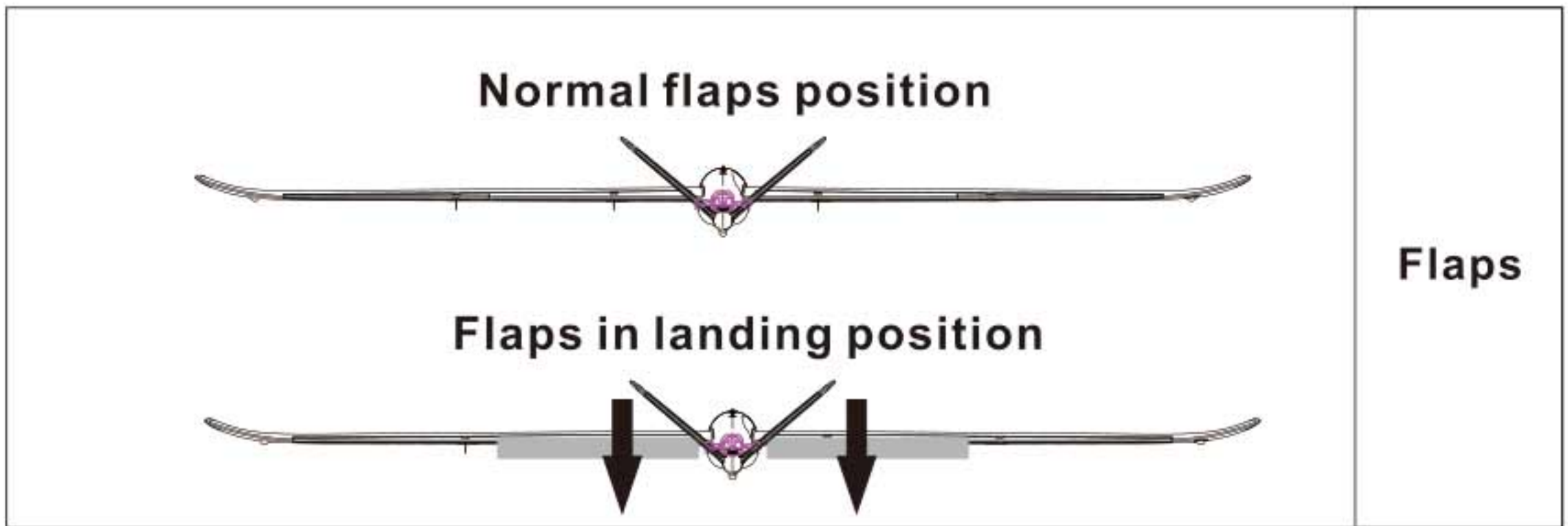

**Check the control throws**

The suggested control throw settings for **ROC HOBBY** V-tail are as follows (Dual rate setting):

	High Rate	Low Rate
Ailerons	18mm up/down	11mm up/down
Elevator	13mm up/down	8mm up/down
Rudder	12mm up/down	7mm up/down
Flaps	Full 18mm down	

**Tips:** At first flight, fly the model in low rate. When you first use high rates, be sure to fly at medium speeds since high rates will allow EXTREME maneuvering.

**Check the motor rotating direction**

- The propeller should rotate clockwise when viewing the plane from the rear.  
**Note:** Be careful not to accidentally discard the propeller hub adapter.  
**CAUTION:** Before testing the propeller, make sure the tail of the plane is firmly on the model stand and ensure there are no people or objects in the range of the propeller.



## Before the model flying

### Find a suitable flying site

Find a flying site clear of buildings, trees, power lines and other obstructions. Until you know how much area will be required and have mastered flying your plane in confined spaces, a site at least the size of two to three football fields should be adequate— a flying field specifically for R/C planes is best. Never fly near people— especially children who can wander unpredictably.

### Perform the range check of your plane

As a precaution, an operational ground range test should be performed before the first flight each time you go out. Performing a range test is a good way to detect problems that could cause loss of control such as low batteries, defective or damaged radio components or radio interference. This usually requires an assistant and should be done at the actual flying site you will be using.

First turn on the transmitter, then install the fully-charged battery into the fuselage. Connect the battery and install the hatch.

Remember, use care not to bump the throttle stick. Otherwise, the propeller will turn and possibly cause damage or injury.

**Note:** Please refer to your **Transmitter Manual** that come with your radio control system to perform a ground range check. If the controls aren't working correctly or if anything seems wrong, don't fly the model until you find and correct the problem. Make certain all the servo wires are securely connected to the receiver and the transmitter batteries are in good connection.

### Monitor your flight time

Monitor and limit your flight time using a timer (such as one on a wrist watch or in your transmitter). When the batteries are getting low you will usually notice a performance drop before the ESC cuts off motor power, so when the plane starts flying slower you should land. Often (but not always), power can be briefly restored after the motor cuts off by holding the throttle stick all the way down for a few seconds.

To avoid an unexpected dead-stick landing on your first flight, set your timer to a conservative 4 minutes. When your alarm sounds you should land right away.

### Take off

The plane can only take off by the hand launch because of the lack of landing gear. To hand launch the V-tail, hold the fuselage on the underside of the airplane. Give a firm throw directly into the wind slightly up (5-10 degrees above the horizon) with the throttle all the way down and the propeller not spinning. After release, when the propeller is clear of your hands, throttle up to climb out.

**Warning:** Do not engage the throttle while you grip the plane in your hand to avoid any body injuries due to the high speed rotating rotate parts of the plane.

### Flying

Always choose a wide-open space for flying your plane. It is ideal for you to fly at a sanctioned flying field. If you are not flying at an approved site, always avoid flying near houses, trees, wires and buildings. You should also be careful to avoid flying in areas where there are many people, such as busy parks, schoolyards, or soccer fields. Consult laws and ordinances before choosing a location to fly your aircraft.

### Landing

Land the model when you hear the motor pulsing (LVC) or if you notice a reduction in power. If using a transmitter with a timer, set the timer so you have enough flight time to make several landing approaches.

Recharge the battery and repair the model as needed. The model's nose wheel and bottom skids let the model land on the hard surfaces when needed (which may damage the propeller). Align model directly into the wind and fly down to the ground. Fly the airplane down to the ground using 1/4-1/3 throttle to keep enough energy for proper flare. Before the model touches down, always fully decrease throttle to avoid damaging the propeller or other components.

### Maintenance

The V-tail is made from PA and polythene. Repairs to the foam can be made using virtually any adhesive (hot glue, regular CA, epoxy, etc). When parts are not repairable, see the Spare Parts List for ordering by Item number.

Always check to make sure the screws for the control horns and any screws related to high speed rotating parts are firmly fastened in place; especially the nuts of the propeller adaptor which holds the propeller into place.

## Troubleshooting

<b>Problem</b>	<b>Possible Cause</b>	<b>Solution</b>
Aircraft will not respond to the throttle but responds to other controls.	ESC is not armed. Throttle channel is reversed.	Lower throttle stick and throttle trim to lowest settings. Reverse throttle channel on transmitter.
Extra propeller noise or extra Vibration.	Damaged spinner, propeller, motor or motor mount. Loose propeller and spinner parts. Propeller installed backwards.	Replaced damaged parts. Tighten parts for propeller adapter, propeller and spinner.
Reduced flight time or aircraft underpowered.	Flight battery charge is low. Propeller installed backward. Flight battery damaged.	Remove and install propeller correctly. Completely recharge Flight battery. Remove and install propeller correctly. Replace flight battery and obey flight battery instructions.
Control surface does not move, or is slow to respond to control inputs.	Control surface, control horn, linkage or servo damage, Wire damaged or connections loose.	Replace or repair damaged parts and adjust controls. Do a check of connections for loose wiring.
Control reversed.	Channels need be reversed in the transmitter.	Do the Control Direction Test and adjust controls for aircraft and transmitter.
Motor loses power. Motor power pulses then motor loses power.	Damage to motor, or battery. Lose of power to aircraft. ESC uses default soft Low Voltage Cutoff(LVC).	Do a check of batteries, transmitter, receiver, ESC, motor and wiring for damage (replace as needed). Land aircraft immediately and Recharge flight battery.
LED on receiver flashes slowly.	Power lose to receiver.	Check connection from ESC to receiver. Check servos for damage. Check linkages for binding.

# AMA

If you are not already a member of the AMA, please join, The AMA is the governing body of model aviation and membership provided liability insurance coverage, protects modelers' rights and interests and is required to fly at most R/C sites.

## Academy of Model Aeronautics

5151 East Memorial Drive

Muncie, IN 47302-9252

Ph.(800)435-9262

Fax(765)741-0057

Or via the Internet at: <http://www.modelaircraft.org>



## Academy of Model Aeronautics National Model Aircraft Safety Code Effective January 1, 2011

**A. GENERAL:** A model aircraft is a non-human-carrying aircraft capable of sustained flight in the atmosphere. It may not exceed limitations of this code and is intended exclusively for sport, recreation and/or competition.

All model flights must be conducted in accordance with this safety code and any additional rules specific to the flying site.

1. Model aircraft will not be flown:
  - (a) In a careless or reckless manner.
  - (b) At a location where model aircraft activities are prohibited.
2. Model aircraft pilots will:
  - (a) Yield the right of way to all man carrying aircraft.
  - (b) See and avoid all aircraft and a spotter must be used when appropriate.  
(AMA Document #540-D-See and Avoid Guidance.)
  - (c) Not fly higher than approximately 400 feet above ground level within three (3) miles of an airport, without notifying the airport operator.
  - (d) Not interfere with operations and traffic patterns at any airport, heliport or seaplane base except where there is a mixed use agreement.
  - (e) Ensure the aircraft is identified with the name and address or AMA number of the owner on the inside or affixed to the outside of the model aircraft.  
(This does not apply to model aircraft flown indoors).
  - (f) Not operate aircraft with metal-blade propellers or with gaseous boosts except for helicopters operated under the provisions of AMA Document #555.
  - (g) Not operate model aircraft while under the influence of alcohol or while using any drug which could adversely affect the pilot's ability to safely control the model.
  - (h) Not operate model aircraft carrying pyrotechnic devices which explode or burn, or any device which propels a projectile or drops any object that creates a hazard to persons or property.



## AMA

### Exceptions:

- ◆ Free Flight fuses or devices that burn producing smoke and are securely attached to the model aircraft during flight.
  - ◆ Officially designated AMA Air Show Teams (AST) are authorized to use devices and practices as defined within the Team AMA Program Document (AMA Document #718).
3. Model aircraft will not be flown in AMA sanctioned events, air shows or model demonstrations unless:
    - (a) The aircraft, control system and pilot skills have successfully demonstrated all maneuvers intended or anticipated prior to the specific event.
    - (b) An inexperienced pilot is assisted by an experienced pilot.
  4. When and where required by rule, helmets must be properly worn and fastened. They must be OSHA, DOT, ANSI, SNELL or NOCSAE approved or comply with comparable standards.

### B. RADIO CONTROL (RC)

1. All pilots shall avoid flying directly over unprotected people, vessels, vehicles or structures and shall avoid endangerment of life and property of others.
2. A successful radio equipment ground-range check in accordance with manufacturer's recommendations will be completed before the first flight of a new or repaired model aircraft.
3. RC model aircraft must use the radio-control frequencies currently allowed by the Federal Communications Commission (FCC). Only individuals properly licensed by the FCC are authorized to operate equipment on Amateur Band frequencies.
4. RC model aircraft will not operate within three (3) miles of any pre-existing flying site without a frequency-management agreement (AMA Documents #922-Testing for RF Interference; #923- Frequency Management Agreement)
5. With the exception of events flown under official AMA Competition Regulations, excluding takeoff and landing, no powered model may be flown outdoors closer than 25 feet to any individual, except for the pilot and the pilot's helper(s) located at the flight line.
6. Under no circumstances may a pilot or other person touch a model aircraft in flight while it is still under power, except to divert it from striking an individual. This does not apply to model aircraft flown indoors.
7. RC night flying requires a lighting system providing the pilot with a clear view of the model's attitude and orientation at all times.
8. The pilot of a RC model aircraft shall:
  - (a) Maintain control during the entire flight, maintaining visual contact without enhancement other than by corrective lenses prescribed for the pilot.
  - (b) Fly using the assistance of a camera or First-Person View (FPV) only in accordance with the procedures outlined in AMA Document #550.

### C. FREE FLIGHT

1. Must be at least 100 feet downwind of spectators and automobile parking when the model aircraft is launched.
2. Launch area must be clear of all individuals except mechanics, officials, and other fliers.
3. An effective device will be used to extinguish any fuse on the model aircraft after the fuse has completed its function.



Email:[info@rochobby.com](mailto:info@rochobby.com)  
[Http://www.rochobby.com](http://www.rochobby.com)