



Perfect Appearance Excellent Performance

980MM P-40B Flying Tiger

Operating Manual



Specifications

Wingspan.....	980 mm (38.6 in)
Length.....	825 mm (32.5 in)
Weight	1240 g (43.7 oz)
Wing Area.....	16.4 dm ² (254 in ²)
Wing Load.....	75.6 g/dm ² (0.17 oz/in ²)
Radio Controls.....	6 Channel



Please visit both our Facebook fanpage and our homepage for updated product information



WARNING

 **WARNING:** Read the ENTIRE instruction manual to become familiar with the features of the product before operating. Failure to operate the product correctly can result in damage to the product, personal property and cause serious injury.

This is a sophisticated hobby product and NOT a toy. It must be operated with caution and common sense and requires some basic mechanical ability. Failure to operate this Product in a safe and responsible manner could result in injury or damage to the product or other property. This product is not intended for use by children without direct adult supervision.

This manual contains instructions for safety, operation and maintenance. It is essential to read and follow all the instructions and warnings in manual, prior to assembly, setup or use, in order to operate correctly and avoid damage or serious injury.

Safety Precautions and Warnings

As the user of this product, you are solely responsible for operating in a manner that does not endanger yourself and others or result in damage to the product or the property of others. This model is controlled by a radio signal subject to interference from many sources outside your control. This interference can cause momentary loss of control so it is advisable to always keep a safe distance in all directions around your model, as this margin will help avoid collisions or injury.

Age Recommendation: Not for children under 14 years. This is not a toy.

- Never operate your model with low transmitter batteries.
- Always operate your model in an open area away from cars, traffic or people.
- Avoid operating your model in the street where injury or damage can occur.
- Never operate the model in the street or in populated areas for any reason.
- Carefully follow the directions and warnings for this and any optional support equipment (chargers, rechargeable battery packs, etc.) you use.
- Keep all chemicals, small parts and anything electrical out of the reach of children.
- Moisture causes damage to electronics. Avoid water exposure to all equipment not specifically designed and protected for this purpose.
- Never lick or place any portion of your model in your mouth as it could cause serious injury or even death.



Table of Contents

Safety.....	3
Introduction and History.....	3
Contents of Kit.....	4
Additional Required Items.....	5
Assembly Instructions.....	5
Generic Binding Instructions.....	12
ESC Information.....	12
Control Surfaces.....	13
Final Assembly, Detailing, and Propeller Set.....	15
Center of Gravity.....	17
Pre-flight Checklist.....	18
Flight Safety.....	18
Daily Flight Checks.....	18
Spare parts list content.....	19
ESC instruction.....	22

Safety

Lithium Polymer (Li-Po) Battery Warning

CAUTION: Always follow the manufacturer's instructions for safe use and disposal of batteries. Fire, property damage, or serious injury can result from the mishandling of Li-Po Batteries.

- By handling, charging or using a Li-Po Battery you assume all risks associated with lithium batteries.
- If at any time the batteries begin to swell, or balloon, discontinue use immediately! Charging or discharging a swelling or ballooning battery can result in fire.
- Always store the batteries at room temperature in a dry area to extend the life of the battery. Always transport or temporarily store the battery in a temperature range of 40-120F. Do not store the battery or model in a car or in direct sunlight. If stored in a hot car, the battery can be damaged or even catch fire.
- Never use a Ni-Mh Charger to charge Li-Po Batteries. Failure to charge the battery with a Li-Po compatible charger may cause fire resulting in personal injury and property damage.
- Never discharge Li-Po Cells below 3V.
- Never leave charging batteries unattended.
- Never charge damaged batteries.

Charging the Flight Battery Warning

- Use a battery charger that is designed to safely charge the Li-Po Battery. Read the charger instructions carefully before use. When charging the battery, make certain the battery is on a heat resistant surface. It is also highly recommended to place the Li-Po Battery inside a fire resistant charging bag readily available at hobby shops or online.

Introduction and History

The Flying Tigers, known officially as the 1st American Volunteer Group (AVG), were a unit of the Chinese Air Force, recruited from U.S. aviators. From late 1941, the P-40B was used by the Flying Tigers. They were divided into three pursuit squadrons, the "Adam & Eves", the "Panda Bears" and the "Hell's Angels".[48]

Compared to opposing Japanese fighters, the P-40B's strengths were that it was sturdy, well armed, faster in a dive and possessed an excellent rate of roll. While the P-40s could not match the maneuverability of the Japanese Army air arm's Nakajima Ki-27s and Ki-43s, nor the much more famous Zero naval fighter in a slow speed turning dogfight, at higher speeds the P-40s were more than a match. AVG leader Claire Chennault trained his pilots to use the P-40's particular performance advantages.[48] The P-40 had a higher dive speed than any Japanese fighter aircraft of the early war years, for example, and could be used to exploit so-called "boom-and-zoom" tactics. The AVG was highly successful, and its feats were widely published, to boost sagging public morale at home, by an active cadre of international journalists. According to their official records, in just 6 1/2 months, the Flying Tigers destroyed 115 enemy aircraft for the loss of just four of their own in air-to-air combat.

The FMS 980MM P-40B Flying Tiger is available in High Speed version which is capable of extreme speeds up to 100mph.

Contents of Kit

Before assembly, please inspect the contents of the kit. The photo below details the contents of the kit and labels the major components "A" thru "O" for your convenience. If any parts are missing or defective, please identify the name or part number (refer to the spare parts list near the end of the manual), then contact the FMS Team.

FMS Team Product Support
3/F, Building B, 3rd Industry Zone, Matigang, Dalingshan Town,
Dongguan City, P.R.C.
Phone: 0086-769-86976655
Email: info@fmsmodel.com

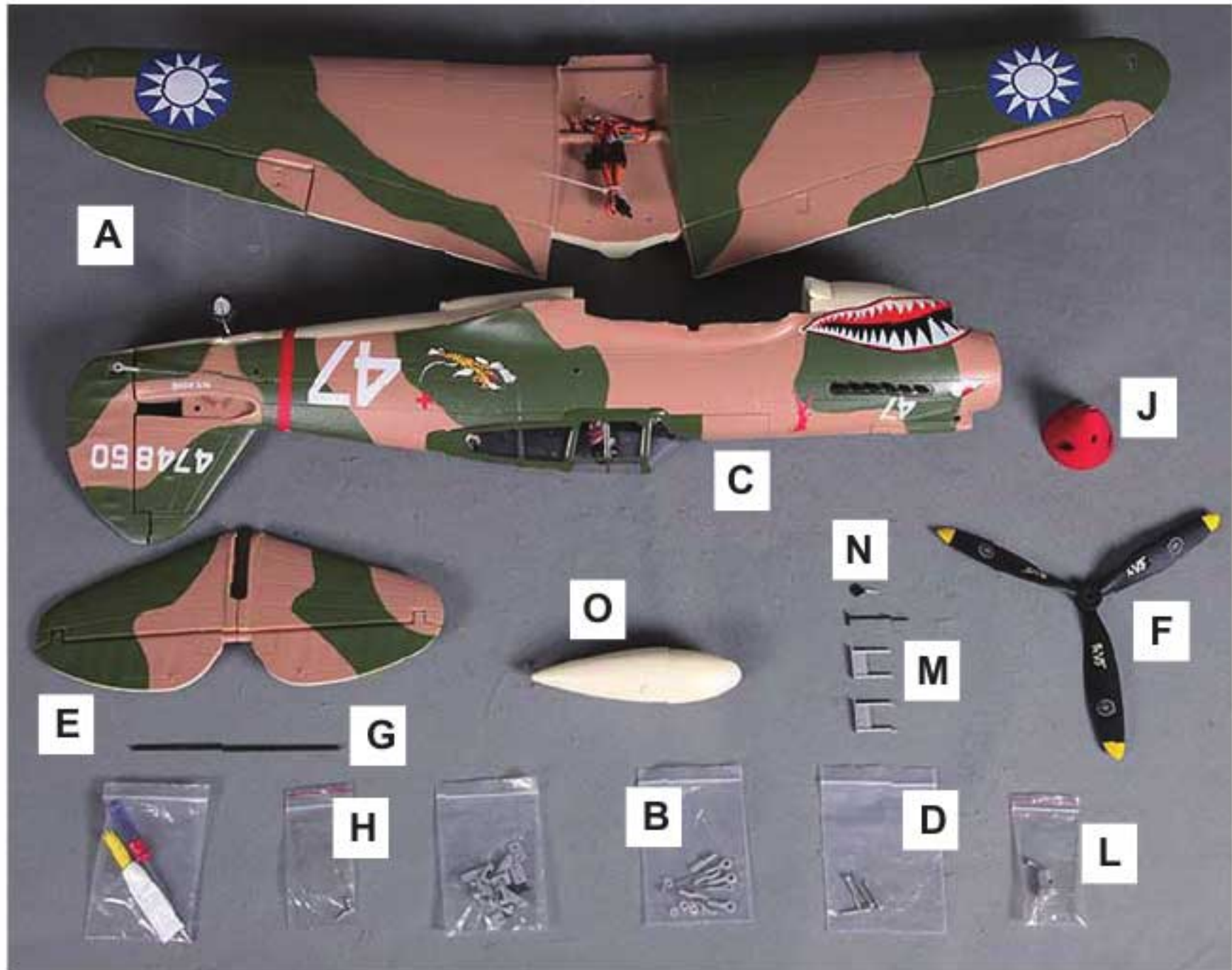

Additional Required Items

Tools and Adhesives

- Glue Brush

Transmitter/Receiver (required for PNP and kit version)

This model requires a 6 channel receiver and transmitter.

Battery/Charger (required for PNP and kit version)

A 14.8V 2200 mAh 25C Li-Po Battery is recommended for the High Speed (HS) version. If using another battery, it must be the same voltage, approximately the same capacity, dimensions, and weight to fit in the fuselage without changing the center of gravity significantly. A standard Li-Po Battery Balancing Charger is required to safely charge the battery. Caution: Using a higher voltage Li-Po Battery than recommended could exceed the maximum capacity of the ESC and motor and result in ESC failure during flight. This would cause a complete loss of control creating a potentially dangerous condition.

Motor/ESC/Servos/Propeller

The HS kit version requires a brushless 3648-KV770 motor, a 70A ESC with 5A SBEC, (6) 9g digital metal gear servos, and a 10.5x7 three blade propeller.

Assembly Instructions

The assembly instructions in this manual have been divided into logical steps. Check boxes have been placed in front of each step to help you keep track of your progress. Please read each step carefully, perform the task per the instructions, and mark when completed. If you are unavoidably interrupted before completing a step, it is advisable to make a detailed notation of any unfinished items to ensure the step is fully completed when you return to the task. Refer to the "Contents of Kit" photos if you need help identifying a part.

Install the aileron control horns

- 1) Locate the wing "A" and parts bag "B" which contains the aileron control horns, backing plate, screws, and control rod linkages.
- 2) Insert the control horns into the holes in the bottom surface of each aileron, with the horn pointing towards the hinge line of the wing (fig. 1). Place the control horn backing plate on the top side of the aileron surface. Using the provided screws, secure each control horn from the backing plate side. (fig. 2)

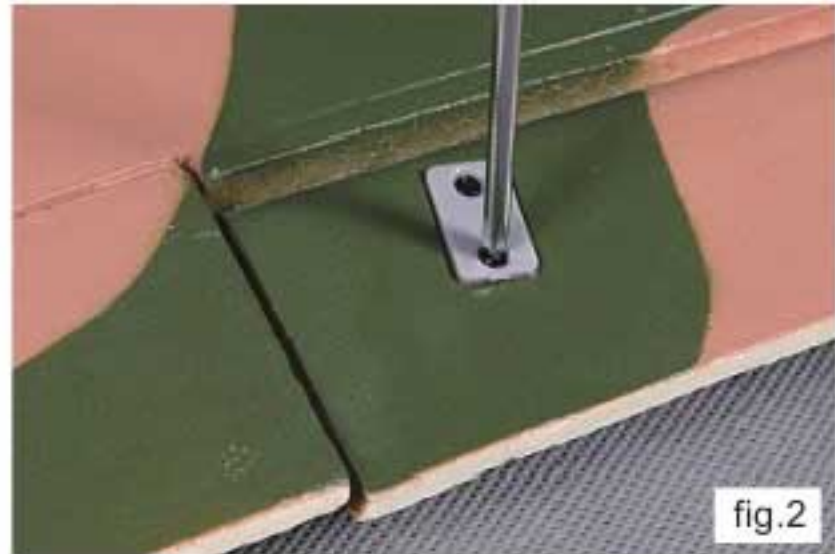
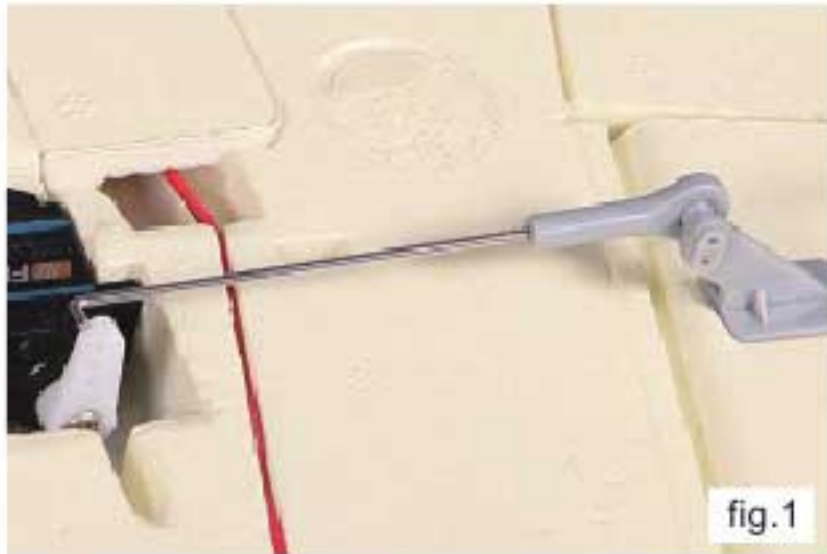

Connect the aileron control rod linkages

- 3) Slide the provided piece of fuel tubing over the control rod linkage and then insert the control rod linkage thru the desired hole in the aileron servo arm (fig. 3). Note: For a single rate transmitter use the first hole to achieve a high rate setting. Use the third hole nearest the servo to achieve a low rate setting.
- 4) Press the hole in the clevis over the end of the control rod linkage, rotate it and snap the base of the clevis over the control rod linkage (fig. 4).

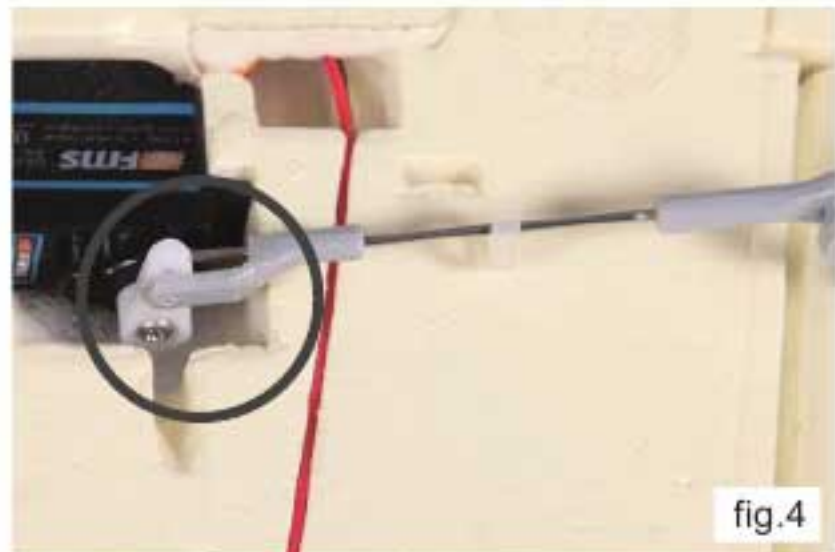
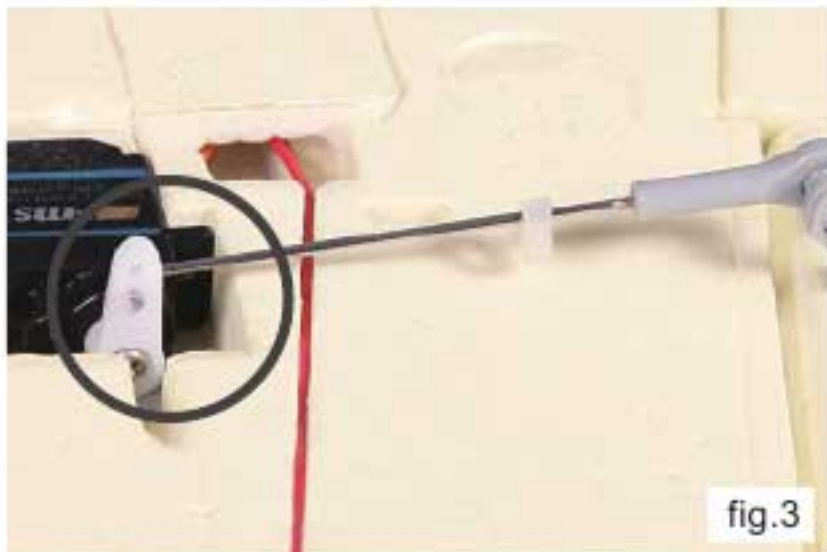

- 5) Slide the fuel tubing over the clevis to secure it (fig. 5). Note: Do not slide the fuel tubing too far or binding of the servo arm could result (fig. 6). Repeat steps 3-5 for the other aileron control rod linkage.

Connect the flap control rod linkages

- 6) Connect the flap control rod linkages in the same manner as the aileron control rod linkages.

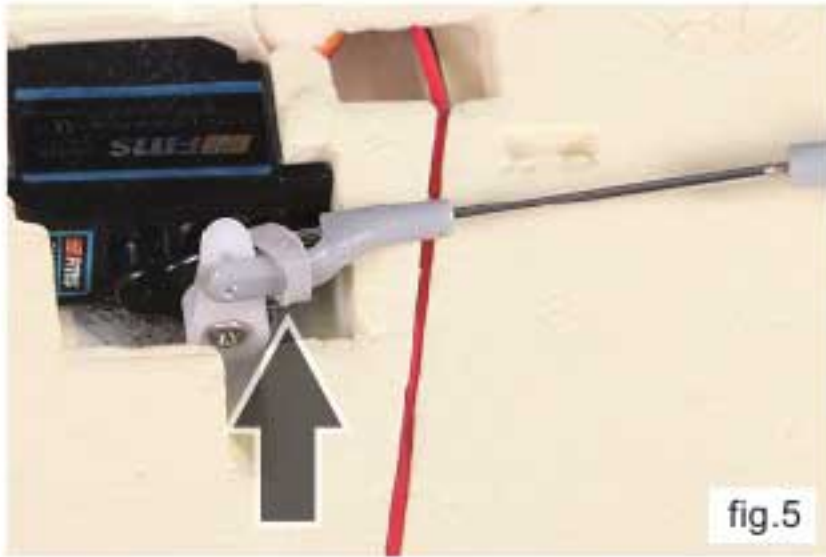

fig.5

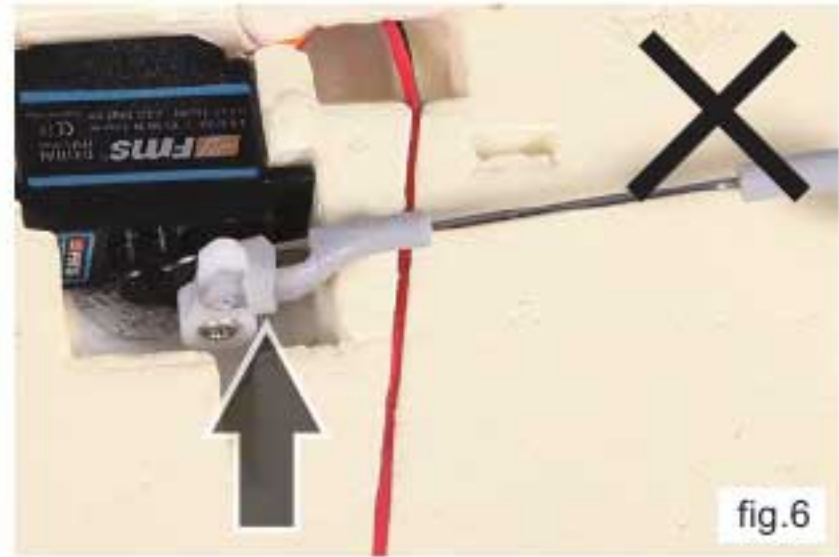

fig.6

Install the Wing

- 7) Locate the fuselage "C", remove the canopy, and turn the fuselage over so the bottom side is facing up (fig. 7).
- 8) Begin to install the wing by guiding the servo leads thru the opening in the bottom of the fuselage as you lower the wing into position (fig. 8).

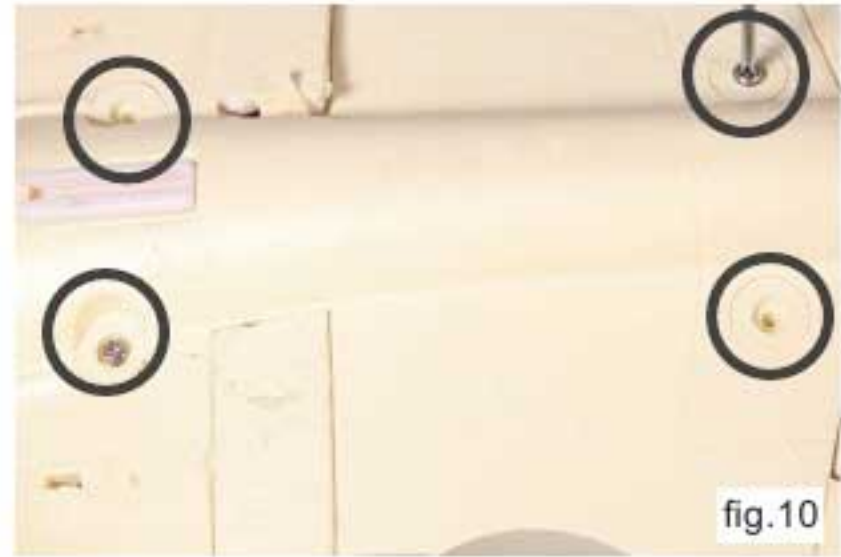

fig.7



fig.8

- 9) Insert the nose on the leading edge side of the wing into the notch in the fuselage (fig. 9). Continue to guide the servo leads thru the opening in the fuselage by pulling on them from the canopy side of the fuselage as you fully seat the wing in position.
- 10) Secure the wing with the four provided machine screws "D" (fig. 10).



Install the horizontal stabilizer

- 11) Locate the left half of the horizontal stabilizer "E". Align the notch in the stabilizer with the plastic tongue protruding from the fuselage (fig. 11).
- 12) Press the left half of the horizontal stabilizer into position (fig. 12).



- 13) Insert the fiberglass connecting tube "G" into the left side stabilizer (fig. 13). Slide the tube approximately halfway in. Do not force it in farther than it will slide. This will push the connecting tube into the foam and prevent it from fully inserting into the right side stabilizer half.
- 14) While holding the left side stabilizer in place, guide the right side stabilizer "F" over the connecting tube and align the notch with the plastic tongue (fig. 14).

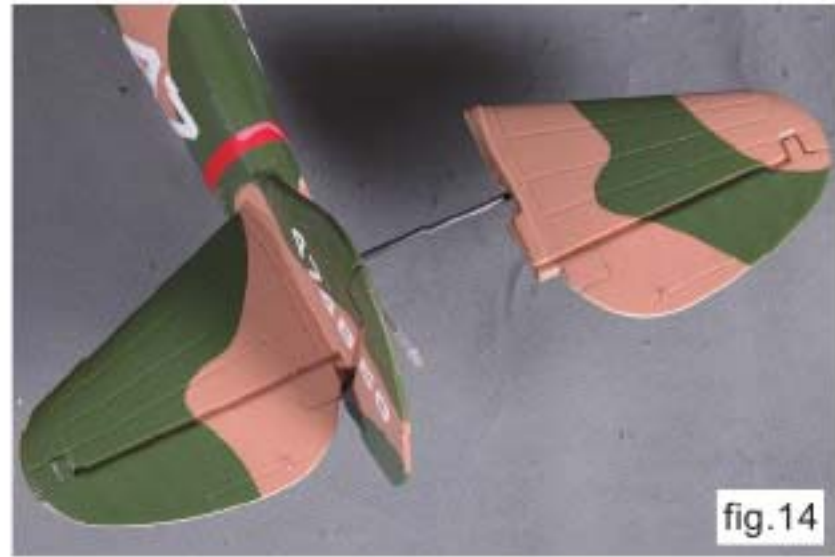

- 15) Press the right side stabilizer into place (fig. 15).
- 16) Turn the fuselage over. Secure the horizontal stabilizer with the two supplied screws from bag "H" (fig. 16).

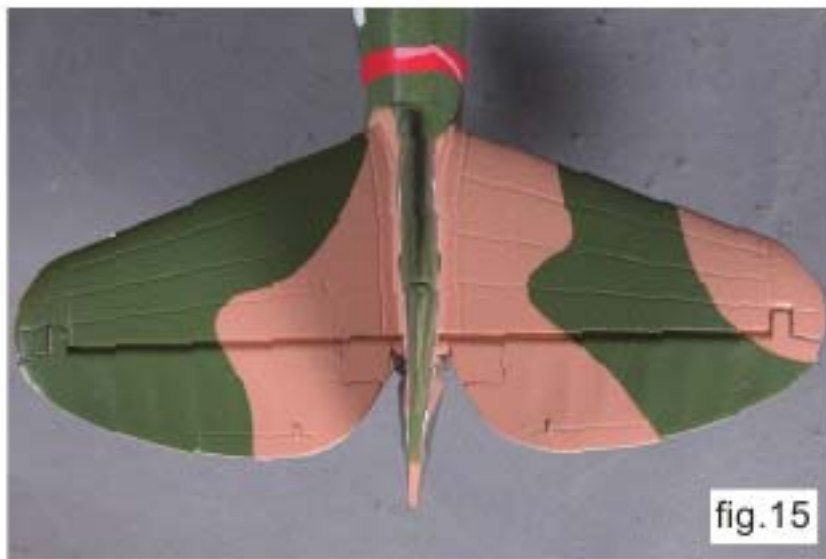

- 17) Connect the left and right elevator surfaces by installing the provided screw from bag "H" as shown (fig. 17).



Connect the elevator control rod linkages

- 18) Press the socket-style linkage connectors over the corresponding ball end on the control horn located on the underside of the elevator. (fig.18).



fig.18

Receiver Connection

- 20) Connect the labeled leads per the receiver connection diagram (fig. 19). There is a Y-harness for the ailerons and a connection board for the retractable gear and LED lights that must be used to combine the leads prior to making a connection to the receiver (fig. 20).

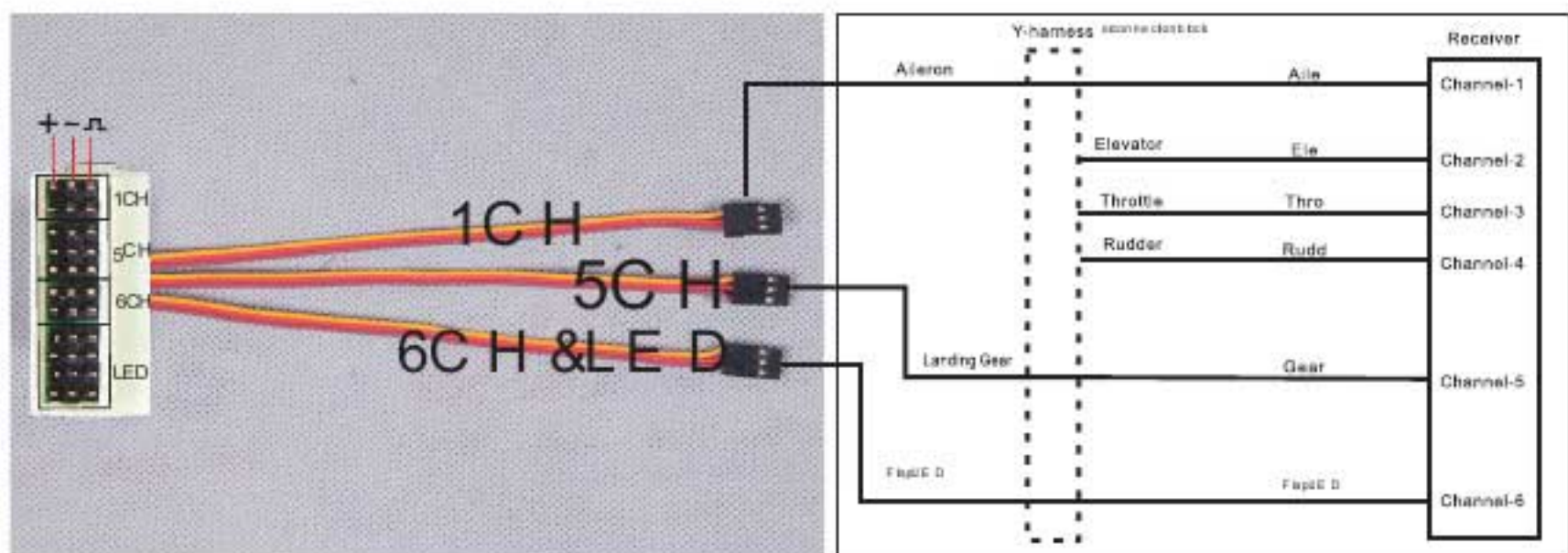
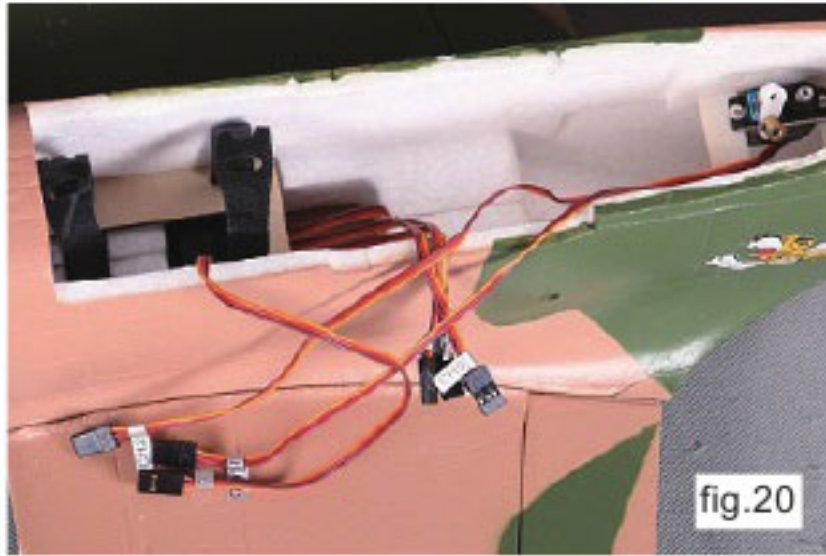

fig.19

Install the battery

- 21) Insert the battery into the battery compartment as shown (fig. 21). Secure the battery in place with the hook and loop strap.



Generic Binding Instructions

Binding is the process of programming your receiver to respond to your specific transmitter. Always follow your radio equipment manufacturer's specific binding instructions. Below is a typical generic procedure for reference:

1. Power off the transmitter.
2. Set the throttle control on the transmitter to its lowest position (all other controls should be at their neutral position).
3. Install binding plug in receiver bind port.
4. Connect the battery to the ESC.
5. The receiver LED will flash rapidly.
6. Turn on the transmitter while holding the bind button or switch in the bind position.
7. When the receiver binds, the LED on the receiver will turn on and remain steady.
8. Remove the binding plug from the receiver.

Note: We recommend re-binding the radio after all the control throw settings are adjusted. This will keep the servos from moving full stroke while the transmitter and receiver connect.

ESC Information

Please refer to the ESC instruction at the end of Manual for detaler information about your programmable ESC.

Motor Rotation

The motor and ESC comes pre-connected. The direction of motor rotation should be counterclockwise (fig. 22). If the motor is rotating in the wrong direction, simply reverse two of the three motor wires to change the direction of rotation.



Control Surfaces

Center Adjustment (trim)

1. Follow all safety precautions as outlined in this manual and your transmitter manufacturer's manual, including setting the throttle to the off position.
2. Turn on the transmitter and plug in the ESC battery.
3. Center all the trim controls on the transmitter.
4. Look at all the control surfaces to determine which ones need adjustment.
5. Unplug the ESC battery and turn off the transmitter before attempting any adjustments.
6. Adjust clevises as necessary to center control surfaces to their neutral position.
7. Repeat steps 1 thru 4 to verify adjustments.
8. If more adjustment is required, repeat steps 5 and 6 until process is completed.

Please see the following for reference; ailerons (fig. 23), rudder, elevator and, rear landing gear (fig. 24). Note: the rudder and rear landing gear neutral position is adjusted by loosening one of the screws on the control connector and moving the linkage rod. Tighten the screw when the adjustment is complete (fig. 25). The other control surfaces are adjusted by disconnecting the appropriate end of the control rod linkage and turning the threaded connector on the linkage rod.



fig.23



fig.24



fig.25

Direction Check

Turn on your transmitter and receiver. Viewing the model from the rear, move the controls on the transmitter per the instructions that follow and verify the control surfaces are responding in the appropriate direction. You may have to reverse the direction of one or more channels on your transmitter to correct any issues.

1. Move the left joystick to the right. The rudder should move to the right. Move the joystick to the left. The rudder should move to the left. Reverse channel on transmitter if necessary.
2. Move the right joystick down towards the bottom of the transmitter. The elevator should move up. Move the joystick towards the top of the transmitter. The elevator should move down.
3. Move the right joystick to the right. The right aileron should go up. The left aileron should go down. Move the joystick to the left. The right aileron should go down. The left aileron should go up.

Travel Settings (throw)

Adjust the throw by moving the clevis position on the control surface horns. A commercially available gauge is helpful in this task though not required. If you have a single rate transmitter, adjust throws to low rate settings. If you have a dual rate transmitter, adjust the throws to achieve high rate settings.

Aileron Control Throw Setting (low rate)

10 mm up/down (fig. 26-28). Pictures are for reference only on how to use the gauge.

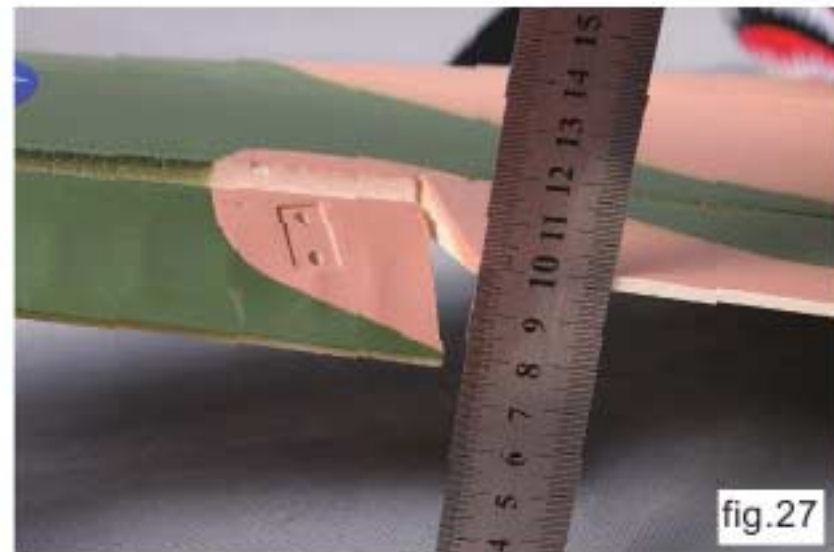
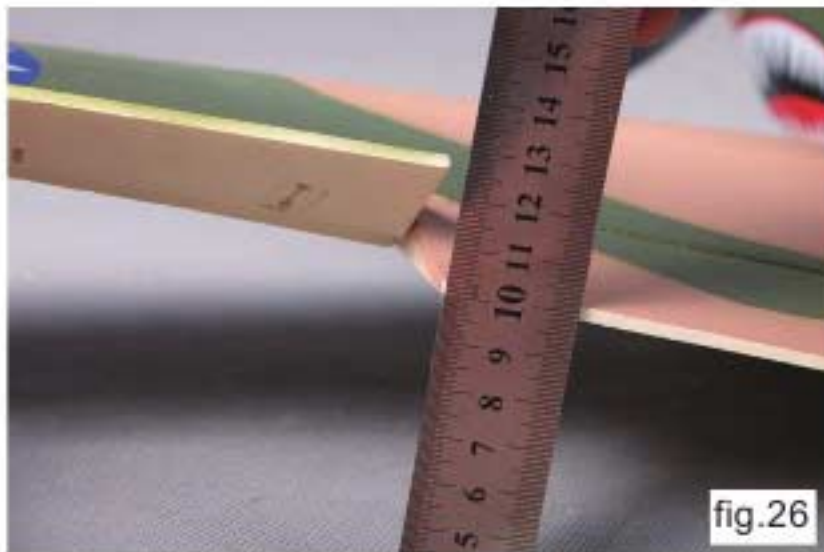

Elevator Control Throw Setting (low rate)

8 mm up/down

Rudder Control Throw Setting (low rate)

7 mm left/right

Flap Control Throw Setting

10 mm mid down

25 mm full down

Note: Measure the throw (deflection) at the widest point (chord) of each control surface.

Dual Rates and Exponential Recommendations

On many transmitters, dual rates can be setup for aileron, elevator, and rudder channels. If your transmitter is capable, designate a switch on the transmitter to change between a low and high rate of servo travel for each channel. Low rates are for normal flying. High rates are for extreme aerobatics.

To use dual rates, the control surface throw settings should be set to equal the high rate settings. When the transmitter switch is in the high rate position, the control surface will travel 100%. When the transmitter switch is in the low rate position, the servo will travel less than 100% (a percentage that you determine) to make the control surface throw equal to the low rate deflection.

Aileron high rate 14 mm up/down

Elevator high rate 15 mm up/down

Rudder high rate 12 mm left/right

Final Assembly, Detailing, and Propeller Set

- 1) Locate the machine gun sets "M". Test fit one of the gun sets on the leading edge side of the wing. Match the color and taper of top side of the wing to the corresponding color and taper of the gun set (fig. 29).
- 2) Once you have determined where each gun set fits, remove them, apply glue evenly, and re-install (fig.30).

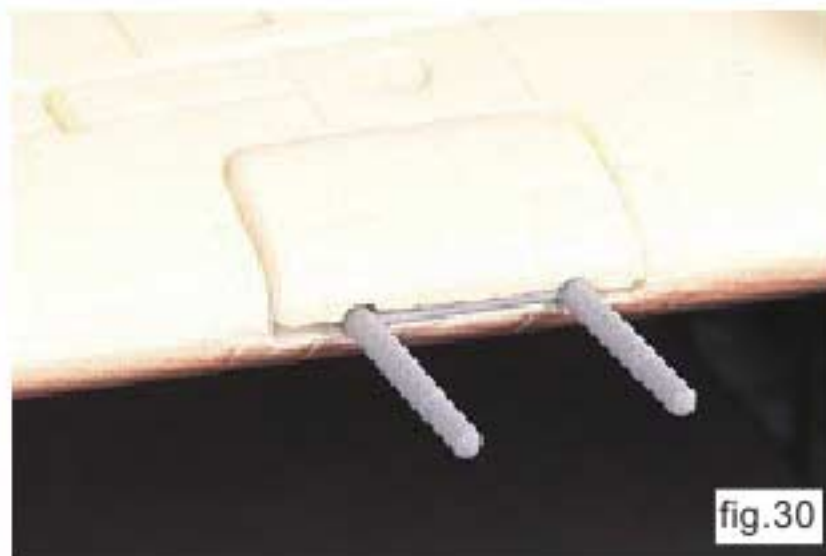
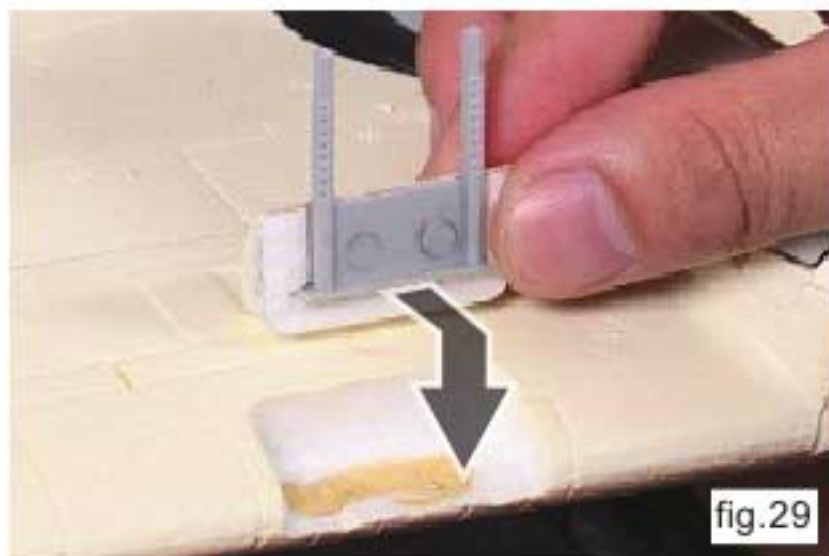

- 4) Slide the external fuel tank "O" into the slot on the bottom of the fuselage as shown (fig.31-32). Note: This step is optional as the external fuel tank could reduce performance.

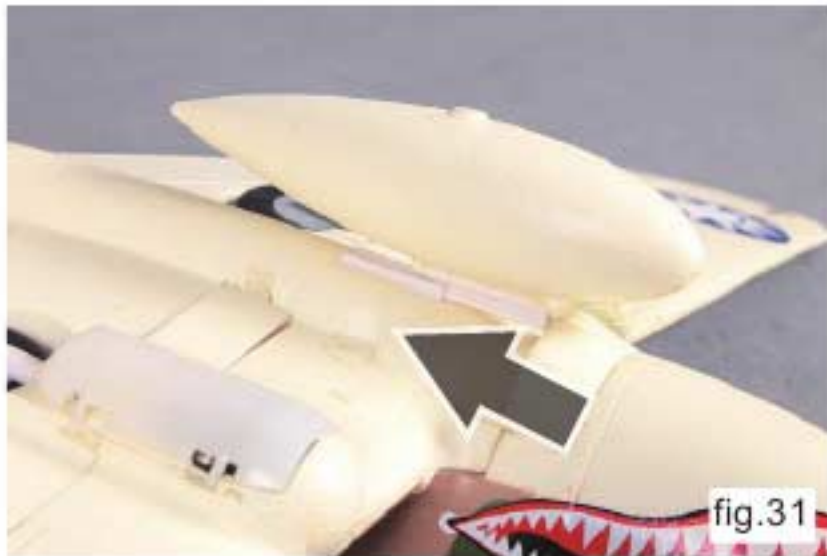

fig.31



fig.32

Install the Propeller Assembly

- 5) Prior to installing the propeller assembly, balancing is recommended. There are commercially available balancers for this task. Please follow the manufacturer's instructions carefully.
- 6) Key the propeller assembly to the motor shaft by fitting the assembly over the hex nut on the shaft "J" (fig. 33).
- 7) Install the propeller to the motor shaft and make sure the root of the propeller sits right on the saddle with the painted propeller tips facing the front of the plane. Secure the bullet into place using a screw driver. (fig.34)
- 8) Secure the spinner into place using the included machine screw. (fig. 35-36)



fig.33



fig.34



fig.35



fig.36

Center of Gravity

Before balancing your model, make sure the it is completely assembled, the battery is installed, and the retractable landing gear is in the lowered position. The recommended center of gravity (CG) for your model is 45-50 mm from the wing's leading edge (measured at point of contact with fuselage). Lightly mark the ideal center of gravity position on the top surface of the wing on each side of the fuselage. Support the plane inverted at the marks made on the top of the wing with your fingers or a commercially available balancing stand. It should be level or just slightly nose down. Adjust the position of battery as necessary to achieve the proper balance.

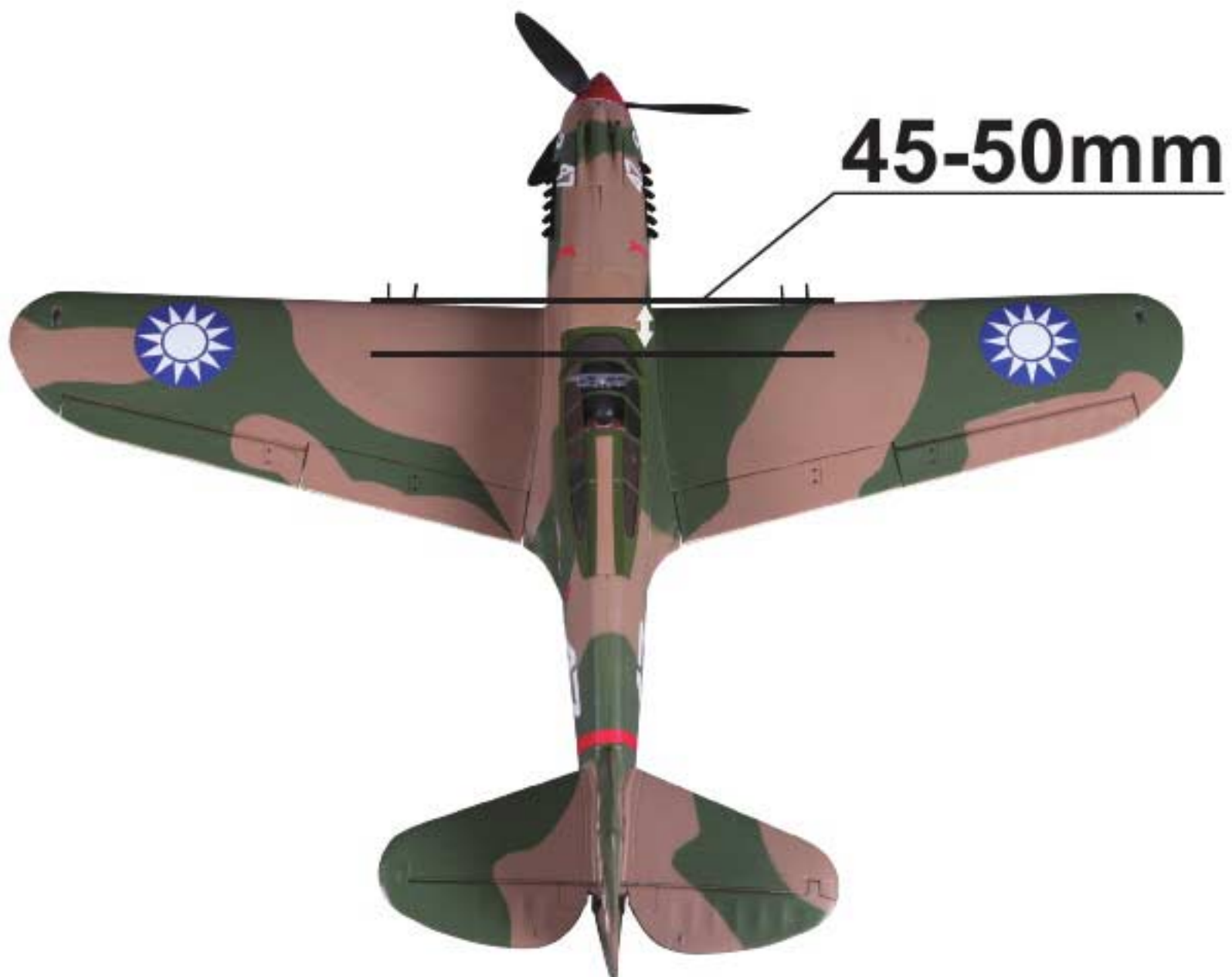

Pre-flight Checklist

Prior to first flight:

- 1.Ensure your transmitter and ESC batteries are fully charged per manufacturer's instructions.
- 2.Ensure propeller is properly secured.
- 3.Ensure receiver and ESC battery are secure.
- 4.Check all control surface actuating hardware (linkages, screws, nuts, bolts, etc.)
- 5.Perform a range test on the radio equipment.
- 6.Check control surfaces for proper direction and throw.
- 7.Check center adjustment of each control surface.
- 8.With someone holding the aircraft, start the motor and make sure it runs smoothly and in a CCW direction when viewed from the front. Ensure it will transition from off to high throttle and back to off.

Flight Safety

- 1.Do not fly in strong winds or bad weather.
- 2.Never fly in crowded areas near people, cars, buildings, power lines, airports, etc. The plane can travel at high speed so choose a wide open space and give yourself plenty of room to operate. Remember you are responsible for the safety of others.
- 3.Not recommended for children under 14 years of age. Children under 12 must have adult supervision.
- 4.Never use or leave the battery charger in a wet environment.
- 5.Keep the model away from heat which can easily destroy the foam structure of the plane, the electronics, or the battery.
- 6.Do not attempt to catch the model while flying.
- 7.Stay clear of the propeller at all times, even when it is not moving because the transmitter could easily be bumped and cause the propeller to move without warning.
- 8.Never leave the model unattended with a battery installed. Injury could be caused by children or unaware adults turning on the transmitter.
9. When preparing for flight, turn the transmitter on and ensure the throttle is off before connecting the battery.

Daily Flight Checks

Prior to first flight:

- 1.Check condition of major components. Ensure wing, tail, motor, and landing gear are secure.
- 2.Check condition of propeller.
- 3.Check all control surface actuating hardware (linkages, screws, nuts, bolts, etc.)
- 4.Check the voltage on the transmitter and ESC batteries.
- 5.Perform a range test on the radio equipment.
- 6.Check control surfaces for proper direction and throw.
- 7.Check center adjustment of each control surface.

Post flight:

1. Disconnect ESC battery
2. Turn off transmitter
3. Remove ESC battery from model.
4. Recharge ESC battery.
5. Store ESC battery away from model in fire proof container.
6. Repair or replace any damaged parts on the model airplane.

Spare parts list content

- FH 101 Fuselage
 - FH 102 Main wing set
 - FH 103 Horizontal stabilizer
 - FH 104 Cockpit
 - FH 105 Spinner
 - FH 106 Propeller (10.5*7 3-blade)
 - FH 107 Oil Tank
 - FH 108 Machine Gun
 - FH 109 Airspeed Head
 - FH 110 Exhaust Pipe
 - FH 111 Motor Mount
 - FH 112 Motor Board
 - FH 113 Main Landing Gear System (A whole set with retract, strut and tires)
 - FH 114 Rear Landing Gear Set
 - FH 115 The inner fairing door
 - FH 116 Motor Shaft
 - FH 117 Linkage Rod
 - FH 118 Screw Set
 - FH 119 Decal Sheet
 - FH 120 Pipe (for elevator)
 - FH 121 LED
 - FH 122 Lamp Cover
 - FMS-Motor-3648 Kv770
 - FMS-ESC-70A
 - FMSSER9MGD (9g digital metal gear servo positive)
 - FMSSER9SLP (9g Positive slow servo flaps For flaps)
- Note:** All of the parts are painted with no decal applied.

Spare Parts Illustration



FH 101

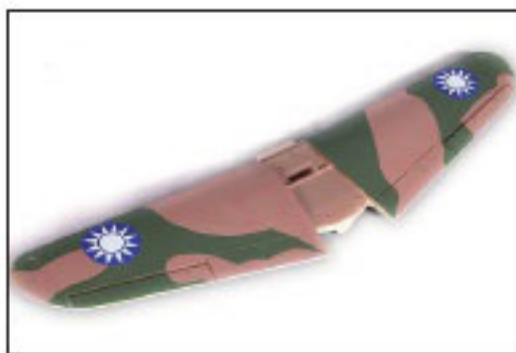

FH 102

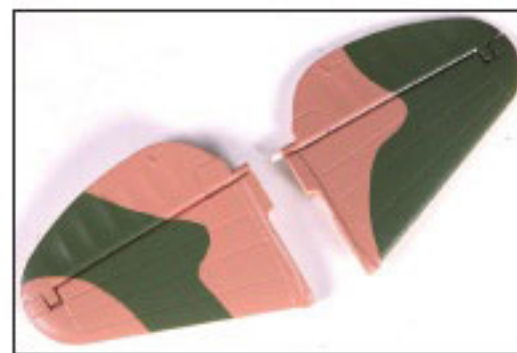

FH 103



FH 104



FH 105



FH 106



FH 107

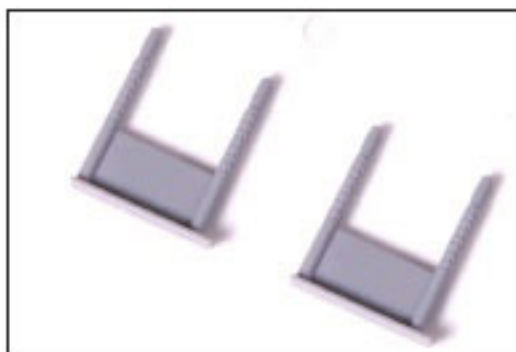

FH 108



FH 109



FH 110



FH 111



FH 112



FH 113



FH 114



FH 115



FH 116



FH 117



FH 118

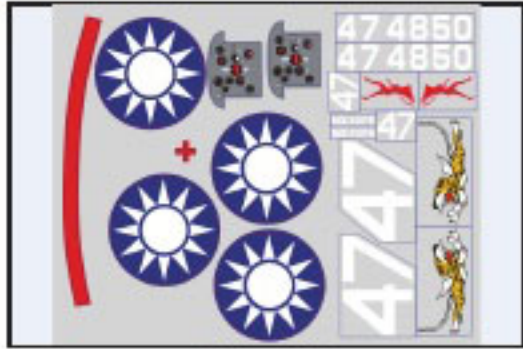

FH 119

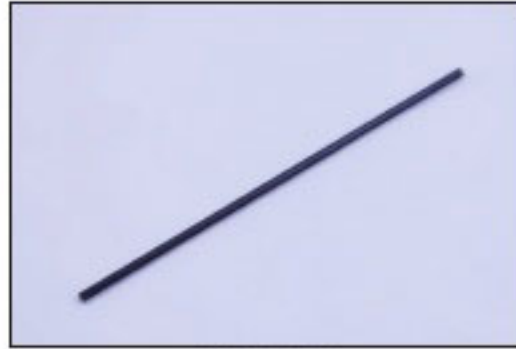

FH 120



FH 121



FH 122



FMS-Motor-3648 Kv770



FMS-ESC-70A



FMSSER9MGD 9g



FMSSER9SLP 9g

ESC instruction

Wires Connection:

The electronic speed controller can be connected to the motor by soldering directly or with high quality connectors. Always use new connectors, which should be soldered carefully to the cables and insulated with heat shrink tube. The maximum length of the battery pack wires shall be within 6 inches.

- Solder controller to the motor wires.
- Solder appropriate connectors to the battery wires.
- Insulate all solder connectors with heat shrink tubes.
- Plug the "JR" connector into the receiver throttle channel.
- Speed Controller Red and Black wires connects to battery pack Red and Black wires respectively.

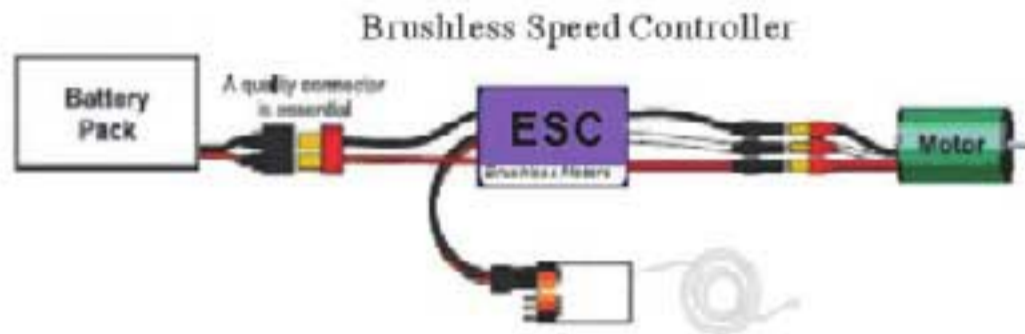

Specification:

Model #	Cont. Current(A)	Burst Current (A) 10s.	Battery cell NiXX/Lipo	Weight (g)	BEC Output	Size (mm) W*L*H	User Program
6A	6A	8A	5-10 NC \ 2-3 Lipo	5	5volts / 2amps	13 x 21 x 4	yes
12A	12A	16A	5-12 NC \ 2-4 Lipo	8	5volts / 1amps	21 x 22 x 4	yes
20A	20A	30A	5-12 NC \ 2-4 Lipo	18	5volts / 3amps	13 x 21 x 4	yes
30A	30A	40A	5-12 NC \ 2-4 Lipo	30	5volts / 3amps	23 x 43 x 6	yes
35A	35A	45A	5-12NC \ 2-4 Lipo	47	5volts / 4amps	28 x 38 x 8	yes
40A	40A	50A	5-12 NC \ 2-4 Lipo	44	5volts / 3amps	28 x 38 x 8	yes
45A	45A	55A	5-12 NC \ 2-4 Lipo	42	5volts / 3amps	31 x 58 x 11	yes
50A	50A	70A	5-18NC \ 2-6 Lipo	45	5.5volts / 5amps	31 x 58 x 11	yes
60A	60A	70A	5-12NC \ 2-4Lipo	50	5.5volts / 3amps	36 x 50 x 8	yes
65A	65A	85A	5-18NC \ 2-6Lipo	58	5.5volts / 5amps	30 x 56 x 11	yes
70A	70A	75A	5-12NC \ 2-6 Lipo	56	5.5volts / 5amps	34 x 52 x 14	yes
85A	85A	100A	5-18NC \ 2-6Lipo	63	5.5volts / 5amps	34 x 52 x 14	yes

Features:

- ◆ Extremely low internal resistance
- ◆ Super smooth and accurate throttle linearity
- ◆ Safety thermal over-load protection
- ◆ Auto throttle shut down in signal loss situation
- ◆ Supports high RPM motors
- ◆ Power arming protection (prevents the motor from accidentally running when switched ON)
- ◆ New advanced programming software

Our ESC allows you to program parameters to fit your specific needs:

Our ESC allows you to program parameters to fit your specific needs:

1. User programmable brake setting (we recommend using brake for only folding props applications)
2. User programmable battery type (LiPo or NiCd/NiMh)
3. User programmable low voltage cutoff setting
4. User programmable factory default setting restore
5. User programmable timing settings (to enhance ESC efficiency and smoothness)
6. User programmable soft acceleration start ups (for delicate gearbox and helicopter applications)
7. User programmable governor mode (for helicopter applications)
8. User programmable motor rotation (clockwise\counterclockwise)
9. User programmable switching frequency
10. User programmable low voltage cutoff type (power reduction or immediate shutdown)

Settings:

1. Brake: ON/OFF

* ON-Sets the propeller to the brake position when the throttle stick is at the minimum position (Recommended for folding props).

* OFF-Sets the propeller to freewheel when the throttle stick is at the minimum position.

2. Battery type: LiPo or NiCad/NiMh

* NiCad/NiMh – Sets Low Voltage protection threshold for NiCad/NiMh cells.

* LiPo – Sets Low voltage protection threshold for LiPo cells and automatically detects the number of cells within the pack.

Note: Selecting the NiCad/NiMh option for the battery type, triggers the ESC to automatically set the cutoff threshold to the factory default of 65%. The cutoff threshold can then be subsequently altered through the Low Voltage protection function, if required. The ESC will read the initial voltage of the NiCad/NiMh pack once it is plugged in and the voltage read will then be used as a reference for the cutoff voltage threshold.

3. Low Voltage Protection Threshold (Cutoff Threshold):

Low / Medium / High

1) For Li-xx packs- number of cells are automatically calculated and requires no user input apart from defining the battery type. This ESC provides 3 setting options for the low voltage protection threshold; Low (2.8V)/ Medium (3.0V)/ High (3.2V). For example: the voltage cutoff options for an 11.1V/ 3 cell Li-Po pack would be 8.4V (Low)/ 9.0V (Med)/ 9.6V (High)

2) For Ni-xx packs-low / medium / high cutoff voltages are 50%/65%/65% of the initial voltage of the battery pack. For example: A fully charged 6 cell NiMh pack's voltage is $1.44V \times 6 = 8.64V$, when "LOW" cutoff voltage is set, the cutoff voltage is: $8.64V \times 50\% = 4.3V$ and when "Medium" or "High" is set, the cutoff voltage is now $8.64V \times 65\% = 5.61V$.

4. Restore factory setup defaults:

Restore - Sets the ESC back to factory default settings;

Brake :	Off
Battery type Detect :	LiPo with Automatic Cell
Low voltage cutoff threshold :	Medium (3.0V/65%)
Timing setup :	Automatic
Soft Acceleration Start Up :	Medium
Governor mode :	OFF
Frequency :	16kHz
Low voltage cutoff type :	Reduce power

5. Timing setup: Automatic / Low / High.

- * Automatic – ESC automatically determines the optimum motor timing
- * Low (7-22 deg) – Setting for most 2 pole motors.
- * High (22-30 deg)-setting for motors with 6 or more poles.

In most cases, automatic timing works well for all types of motors. However for high efficiency we recommend the Low timing setting for 2 pole motors (general in-runners) and high timing for 6 poles and above (general outrunners). For higher speed, High timing can be set. Some motors require different timing setups therefore we suggest you follow the manufacturer recommended setup or use the automatic timing setting if you are unsure.

Note: Run your motor on the ground first after making any changes to your motor timing!

6. Soft Acceleration Start ups: Very Soft / Soft Acceleration/ Start Acceleration

- * Very Soft – Provides initial slow 1.5 sec ramp-up from start to full rpm intended to protect delicate gears from stripping under instant load. This setting is recommended for either fixed wing models equipped with gearboxes and / or helicopters.
- * Soft Acceleration- Provides initial slow 1 sec ramp-up from start to full rpm. This setting is recommended for either fixed wing models equipped with gearboxes and or helicopters.
- * Start Acceleration – Provides quick acceleration start ups with a linear throttle response. This is recommended for fixed wing models fitted with direct drive setups.

7. Active RPM Control (Heli Governor Mode)

- * RPM control off

* **First range:** There will be a 5-second delay from start to full rpm, but if the throttle is cutoff after starting, then the next start will be as normal start.

* **Second range:** There will be a 15-second delay from start to full rpm, but if the throttle is cutoff after starting, then the next start will be as normal start.

Note: Once the Governor Mode is enabled, the ESC's Brake and Low Voltage Cutoff Type settings will automatically be reset to No Brake and Reduce Power respectively regardless of what settings they were previously set.

8. Motor Rotation: Reverse

In most cases motor rotation is usually reversed by swapping two motor wires. However, in cases where the motor cables have been directly soldered to the ESC cables, motor rotation can be reversed by changing the value of setting on the ESC.

9. Switching Frequency: 8 kHz/16kHz

- * 8 kHz – Sets ESC switching frequency for 2 pole motors, e.g. in-runners.
- * 16 kHz – Sets ESC switching frequency for motors with more than 2 poles, e.g. out-runners.

Although 16 kHz is more efficient without Thrust motors, the setup default is 8 kHz due to the higher RF noises caused at 16 kHz.

10. Low Voltage Cutoff Type: Reduce Power / Hard cutoff

- * Reduce Power – ESC reduces motor power when the pre-set (recommended).
- * Hard Cutoff – ESC instantly cuts motor power when the pre-set Low Voltage Protection Threshold value is reached.

Programming Mode Audible Tones

Programming Mode Audible Tones	ESC Functions
0 Throttle Calibration (within the first 4 Sec) ● ● ● ●	

1	Brake * * * *	Brake On /Off
2	Battery type ~ ~ ~ ~ ~ ~ ~ ~	NiCad LiPo
3	Low Voltage Cutoff Threshold *	Low 2.8V/50% Medium 3.0V/60% High 3.2V/65%
4	Restore Factory Setup Defaults - - - -	Restore
5	Timing Setup - - - - - - - - - - - -	Automatic (7-30°) Low (7-22°) High (22-30°)
6	Soft Acceleration Start Ups ∨	Very Soft Soft Acceleration Start Acceleration
7	Governor Mode * * * * ** ** ** ** *** ** ** **	Rpm off Heli first range Heli second range
8	Motor Rotation W W W W	Positive/Reverse
9	Switching Frequency // // // // // // // //	8kHz 16kHz
10	Low Voltage Cutoff Type - - - - - - - -	Reduce Power Hard Cut Off

Using Your New ESC

Improper polarity or short circuit will damage the ESC therefore it is your responsibility to double check all plugs for proper polarity and firm fit BEFORE connecting the battery pack.

Alert Tones

The ESC is equipped with audible alert tones to indicate abnormal conditions at power up.

If the ESC can't enter into working mode after powering up, indicates that you have not setup throttle calibration.

1. Continuous beeping tone (****) – Indicates that the throttle stick is not in the minimum position.
2. Single beeping tone followed by a one second pause (* * * *) – Indicates that the battery pack voltage is not within the acceptable range. (The ESC automatically checks and verifies the battery voltage once the battery is connected).
3. A single beeping tone followed by a short pause (* * * *) – Indicates that the ESC is unable to detect the normal throttle signal from the receiver.

Built-in Intelligent ESC Safety Functions

1. Over-heat protection: When the temperature of ESC exceeds 110 deg C, the ESC will reduce the output power to allow it to cool.
2. Lost Throttle signal protection: The ESC will automatically reduce output power to the motor when it detects a lost

of throttle signal for 2 second, a subsequent loss of throttle signal beyond 2 seconds, will cause the ESC automatically to cut power to the motor.

Powering up the ESC for the first time and setting the Automatic Throttle Calibration

The ZTW ESC features Automatic Throttle Calibration to attain the smoothest throttle response and resolution throughout the entire throttle range of your transmitter. This step is done once to allow the ESC to “learn and memorize” your Transmitter’s throttle output signals and only repeated if you change your transmitter.

1. Switch your Transmitter ON and set the throttle stick to its maximum position.
2. Connect the battery pack to the ESC. Wait for about 2 seconds, the motor will beep for twice, then put the throttle in the minimum position, the motor will also beep, which indicates that your ESC has got the signal range of the throttle from your transmitter.

The throttle is now calibrated and your ESC is ready for operation.

Normal ESC start up procedure:

1. Switch your Transmitter ON and set the throttle to its minimum position.
2. Connect the battery pack to the ESC.
3. When the ESC is first powered up, it emits two sets of audible tones in succession indicating the status of its programming state.
 - * The first set of tones denotes the number of cells in the LiPo pack connected to the ESC. (Three beeps (***) indicates a 3 cell LiPo pack while 4 beeps (****) indicates a 4 cell LiPo pack).
 - * The second set denoting Brake status. One beep (*) for Brake “ON” and two beeps (**) for Brake “OFF” .
 - * The ESC is now ready for use.

Entering the Programming Mode:

1. Switch your Transmitter ON and set the throttle to its maximum position.
2. Connect the battery pack to the ESC.
3. Wait until you hear two short beeps (**) confirming that the ESC has now entered the programming mode.
4. If within 5 seconds, the throttle stick is lowered to its minimum position, an audible tone is emitted confirming that the **throttle calibration** setting has changed. If the throttle stick is left in the maximum position beyond 5 seconds, the ESC will begin the sequence from one function and its associated setting options to another. (Please refer to the table below to cross reference the functions with the audible tones).
5. When the desired tone for the function and setting option is reached, move the throttle stick down to its minimum position. ESC will emit two beeps (**) confirming the new setting has been stored.
6. The ESC only allows the setting of one function at a time. Therefore should you require making changes to other function disconnect the battery pack and wait 5 seconds to reconnect the battery and repeat the above steps.

General Safety Precautions

Do not install the propeller (fixed wing) or drive pinion (helicopter) on the motor when you test the ESC and motor for the first time to verify the correct settings on your radio. Only install your propeller or pinion after you have confirmed that the settings on your radio is correct.

- Never use ruptured or punctured battery cells.
- Never use battery packs that are known to overheat.
- Never short circuit battery or motor terminals.
- Always use proper insulation material for cable insulation.
- Always use proper cable connectors.
- Do not exceed the number of cells or servos specified by the ESC.

Wrong battery polarity will damage the ESC and void the warranty.

- Install the ESC in a suitable location with adequate ventilation for cooling. This ESC has a built-in over heat cutoff protection feature that will immediately cut power to the motor once the ESC temperature exceeds the 230 Deg F/ 110 Deg C high temperature limit.
- Use only batteries that are supported by the ESC and ensure the correct polarity before connecting.
- Switch your Transmitter ON and ensure the throttle stick is in the minimum position before connecting the battery

pack.

- Never switch your transmitter **OFF** while the battery is connected to your ESC.
- Only connect your battery pack just before flying and do not leave your battery pack connected after flying.
- Handle your model with extreme care once the battery pack is connected and keep away from the propeller at all times. Never stand in-line or directly in front of any rotating parts.
- Do not immerse the ESC underwater while powered up.
- Do fly at a designated flying site and abide by the rules and guidelines set by your flying club.

Troubleshooting:

Issue	Possible Reason	Action
Motor doesn't work, but there are audible tones of automatically detection of the number of cells after powering up ESC.	The ESC throttle calibration has not set up.	Set up the ESC throttle calibration.
Motor doesn't work and no audible tone emitted after connecting the battery. Servos are not working either.	Poor/loose Connection between battery Pack and ESC.	Clean connector terminals or replace connector.
	No power	Replace with a freshly charged battery pack
	Poor soldered connections (dry joints)	Re-solder the cable connections
	Wrong battery cable polarity	Check and verify cable polarity
	ESC throttle cable connected to receiver in the reverse polarity	Check the ESC cable connected to the ESC to ensure the connectors are in the correct polarity.
	Faulty ESC	Replace ESC
Motor doesn't work and no audible tone emitted after connecting the battery BUT servos are working.	Poor / loose connection between ESC and motor	Clean connector terminals or replace connectors
	Burnt motor coils	Replace motor
Motor doesn't work after powering up the ESC. An alert tone with two beeping tones followed by a short pause (** ** ** **) is emitted.	Poor soldered connections (dry joints)	Re-solder the cable connections
	The battery pack voltage is not within the acceptable range.	Replace with a freshly charged battery pack Check battery pack voltage
Motor doesn't work after powering up the ESC. An alert tone with a single beeping tone followed by a short pause (* * * *) is emitted.	The ESC is unable to detect the normal throttle signal from the receiver	Check and verify that the ESC cable is connected to the <u>Throttle</u> channel on the receiver. Check the transmitter and receiver to verify that there is throttle signal output. (Connect a spare servo to verify throttle channel operation)
Motor doesn't work after powering up the ESC. An alert tone with continuous beeping tones (****) is emitted.	The throttle stick is not in the <u>minimum</u> position at power up.	Move the throttle stick to the minimum position.

Motor doesn't work after powering up the ESC. ESC emits two long audible tones followed by two short beeps(_ _ **)	Reversed throttle channel caused the ESC to enter the programming mode.	Enter the servo reverse menu on your transmitter and reverse the throttle channel. Note: For Futaba radios set the throttle channel to Reverse.
--	---	--

Issue	Possible Reason	Action
Motor runs in reverse rotation Motor stops running in flight.	Wrong cables polarity between the ESC and the motor.	Swap any two of the three cable connections between the ESC and the Motor or _ access the Motor Rotation function via the ESC programming mode and change the pre-set parameters.
	Lost throttle signal	Check proper operation of the radio equipment. Check the placement of the ESC and the Receiver and check the route of the receiver's aerial and ESC cables to ensure there is adequate separation to prevent RF interference. Install a ferrite ring on the ESC's throttle cable.
	Battery Pack voltage has reached the Low Voltage Protection threshold.	Land the model immediately and replace the battery pack.
Motor restarts abnormally ESC Overheats	Possible bad cable connection	Check and verify the integrity of the cable connections
	Possible RF Interference at the flying field.	The normal operation of the ESC may be susceptible to surrounding RF interference. Restart the ESC to resume normal operation on the ground to verify recurrence. If the problem persists, test the operation of the ESC at a different flying field.
	Inadequate Ventilation	Relocate the ESC to allow better ventilation
	Servos drawing too much current and over loading the ESC.	Use servos that are adequately sized for the ESC. The maximum BEC current drawn should be within the BEC limits.
	Over sized motor or prop	Prop down or resize the motor



Email: info@fmsmodel.com
Http://www.fmsmodel.com



MADE IN CHINA