

BLADE®

#1 BY DESIGN

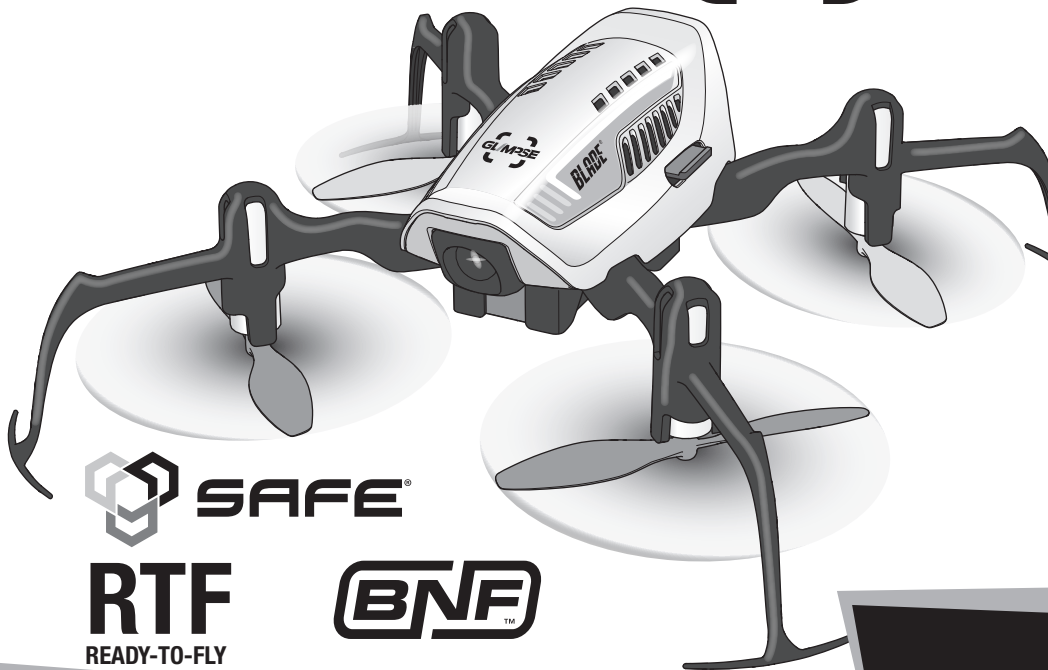

SAFE®

RTF

READY-TO-FLY

BNF™

NOTICE

All instructions, warranties and other collateral documents are subject to change at the sole discretion of Horizon Hobby, LLC. For up-to-date product literature, visit horizonhobby.com and click on the support tab for this product.

Meaning of Special Language

The following terms are used throughout the product literature to indicate various levels of potential harm when operating this product:

WARNING: Procedures, which if not properly followed, create the probability of property damage, collateral damage, and serious injury OR create a high probability of superficial injury.

CAUTION: Procedures, which if not properly followed, create the probability of physical property damage AND a possibility of serious injury.

NOTICE: Procedures, which if not properly followed, create a possibility of physical property damage AND a little or no possibility of injury.

 **WARNING:** Read the ENTIRE instruction manual to become familiar with the features of the product before operating. Failure to operate the product correctly can result in damage to the product, personal property and cause serious injury.

This is a sophisticated hobby product. It must be operated with caution and common sense and requires some basic mechanical ability. Failure to operate this Product in a safe and responsible manner could result in injury or damage to the product or other property. This product is not intended for use by children without direct adult supervision. Do not use with incompatible components or alter this product in any way outside of the instructions provided by Horizon Hobby, LLC. This manual contains instructions for safety, operation and maintenance. It is essential to read and follow all the instructions and warnings in the manual, prior to assembly, setup or use, in order to operate correctly and avoid damage or serious injury.

Age Recommendation: Not for children under 14 years. This is not a toy.

Safety Precautions and Warnings

- Always keep a safe distance in all directions around your model to avoid collisions or injury. This model is controlled by a radio signal subject to interference from many sources outside your control. Interference can cause momentary loss of control.
- Always operate your model in open spaces away from full-size vehicles, traffic and people.
- Always carefully follow the directions and warnings for this and any optional support equipment (chargers, rechargeable battery packs, etc.).
- Always keep all chemicals, small parts and anything electrical out of the reach of children.
- Always avoid water exposure to all equipment not specifically designed and protected for this purpose. Moisture causes damage to electronics.
- Never place any portion of the model in your mouth as it could cause serious injury or even death.
- Never operate your model with low transmitter batteries.
- Always keep aircraft in sight and under control.
- Always move the throttle fully down at rotor strike.
- Always use fully charged batteries.
- Always keep transmitter powered on while aircraft is powered.
- Always remove batteries before disassembly
- Always keep moving parts clean.
- Always keep parts dry.
- Always let parts cool after use before touching.
- Always remove batteries after use.
- Never operate aircraft with damaged wiring.
- Never touch moving parts.

Box Contents:

- Blade® Glimpse™ Quadcopter
- 500mAh 1S 3.7V 25C Li-Po Battery
- 1S 500 mAh USB Charger
- MLP4DSM Transmitter (RTF)
- MLP4DSM Smart Phone Holder (RTF)
- 4 AA Batteries (RTF)
- Smart Phone Holder (BNF)
- Micro-SD card
- Micro-SD USB Reader

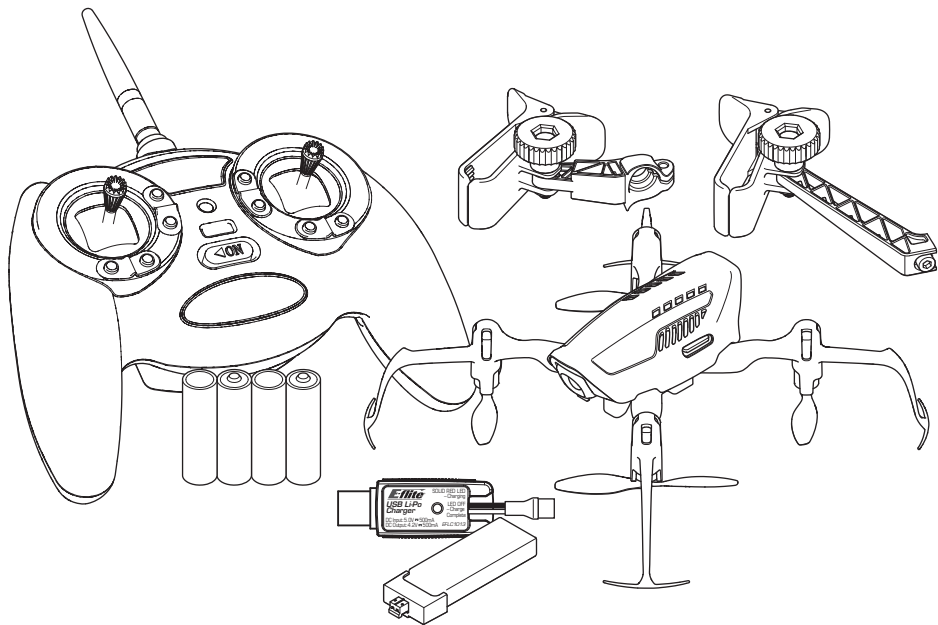

Table of Contents

First Flight Preparation	6	Low Voltage Cutoff (LVC).....	15
Flying Checklist.....	6	Camera Control and App Function	15
Charging Warnings.....	6	Post-Flight Inspection and Maintenance Checklist.....	17
Battery Charging	7	Troubleshooting Guide.....	17
Installing the Transmitter Batteries (RTF)	7	Exploded View.....	19
Installing the Flight Battery	8	Parts Listings.....	20
Transmitter and Receiver Binding	9	Optional Parts.....	20
SAFE™ Technology	10	Limited Warranty.....	20
Transmitter Control.....	11	Warranty and Service Contact Information	22
Rate Selection (RTF).....	12	FCC Information.....	23
Understanding the Primary Flight Controls	13	IC Information	23
LED Codes.....	14	Compliance Information for the European Union	24
Flying the Glimpse	14		

Components	RTF	BNF
Airframe – Blade Glimpse	Included	Included
Motors – 8mm Brushed	Installed	Installed
On-board Electronics – 4-in-1 mixer/ESCs/Gyro	Installed	Installed
Battery – 500mAh 1S 3.7V 25C Li-Po	Included	Included
Charger – 1S USB Li-Po Charger, 500 mAh	Included	Included
Transmitter – MLP4DSM	Included	Required
Micro SD card	Installed	Installed
Smart Device – 5.8 GHz Wi-Fi Capable	Required	Required

Specifications			
Length	6.29 in (160mm)	Propeller Diameter	2.36 in (60mm)
Height	1.97 in (50mm)	Flying Weight	1.83 oz (52 g)

To register your product online, visit www.bladehelis.com

First Flight Preparation

- Remove and inspect contents
- Begin charging the flight battery
- Install the flight battery in the quadcopter (once it has been fully charged)
- Program your computer transmitter
- Bind your transmitter
- Familiarize yourself with the controls
- Find a suitable area for flying

Charging Warnings



CAUTION: All instructions and warnings must be followed exactly. Mishandling of Li-Po batteries can result in a fire, personal injury and/or property damage.

- **NEVER LEAVE CHARGING BATTERIES UNATTENDED.**
- **NEVER CHARGE BATTERIES OVERNIGHT.**
- By handling, charging or using the included Li-Po battery, you assume all risks associated with lithium batteries.
- If at any time the battery begins to balloon or swell, discontinue use immediately. If charging or discharging, discontinue and disconnect. Continuing to use, charge or discharge a battery that is ballooning or swelling can result in fire.
- Always store the battery at room temperature in a dry area for best results.
- Always transport or temporarily store the battery in a temperature range of 40–120° F (5–49° C).
- Do not store battery or model in a car or direct sunlight. If stored in a hot car, the battery can be damaged or even catch fire.

Flying Checklist

- Always turn the transmitter on first**
- Plug the flight battery into the lead from the 4-in-1 control unit
- Allow the 4-in-1 control unit to initialize and arm properly
- Fly the model
- Land the model
- Unplug the flight battery from the 4-in-1 control unit
- Always turn the transmitter off last**

- Always charge batteries away from flammable materials.
- Always inspect the battery before charging
- Always disconnect the battery after charging, and let the charger cool between charges.
- Always constantly monitor the temperature of the battery pack while charging.
- **ONLY USE A CHARGER SPECIFICALLY DESIGNED TO CHARGE LI-PO BATTERIES.** Failure to charge the battery with a compatible charger may cause a fire resulting in personal injury and/or property damage.
- Never discharge Li-Po cells to below 3V under load.
- Never cover warning labels with hook and loop strips.
- Never charge batteries outside recommended levels.
- Never charge damaged batteries.
- Never attempt to dismantle or alter the charger.
- Never allow minors to charge battery packs.
- Never charge batteries in extremely hot or cold places (recommended between 40–120° F or (5–49° C) or place in direct sunlight.

Battery Charging

⚠ CAUTION: Only use chargers specifically designed to charge the included Li-Po battery. Failure to do so could result in fire, causing injury or property damage.

⚠ CAUTION: Never exceed the recommended charge rate.

The Battery Charger (EFLC1013) included with your quadcopter has been designed to safely charge the 1S 3.7V 500mAh 25C Li-Po flight battery. Refer to the charging warnings. It is recommended to charge the battery pack while you are inspecting the aircraft. The flight battery will be required to confirm proper aircraft operation in future steps.

NOTICE: Inspect the battery to make sure it is not damaged e.g., swollen, bent, broken or punctured. Charge only batteries that are cool to the touch and are not damaged.

1. Insert the charger into a USB port. The charger only uses power from the USB port. USB power supplies, such as those used to charge cellular phones, can also be used.

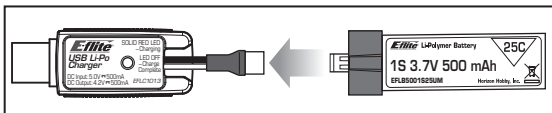

2. Connect the battery to the charger as shown in the illustration above. When you make the connection successfully, the LED on the charger turns solid red, indicating charging has begun. Charging a fully discharged (not over-discharged) 500mAh battery takes approximately 60 minutes. The LED goes out when the charge is complete.

CHARGING (Solid Red LED)

MAX CHARGE (LED OFF)

3. Always disconnect the flight battery from the charger immediately upon completion of charging.

⚠ CAUTION: Once charging is complete, immediately remove the battery. Never leave a battery connected to the charger.

Installing the Transmitter Batteries (RTF)

Install 4 AA batteries into the transmitter, noting polarity. Replace the transmitter batteries when the power LED flashes and the transmitter beeps. We recommend using only alkaline AA batteries in the transmitter, however, it is possible to use rechargeable NIMH batteries.

⚠ CAUTION: If using rechargeable batteries, charge only rechargeable batteries. Charging non-rechargeable batteries may cause the batteries to burst, resulting in injury to persons and/or damage to property.

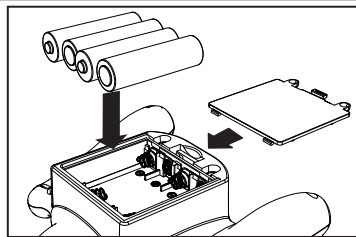

Installing the Flight Battery

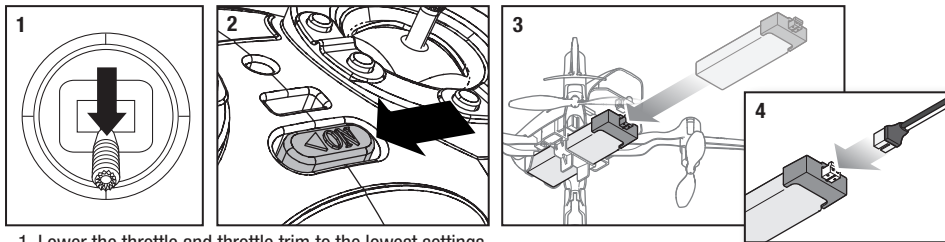

1. Lower the throttle and throttle trim to the lowest settings.
2. Power on the transmitter.
3. Install the battery by sliding it into the battery mounting slot.
4. Connect the battery cable to the 4-in-1 control unit as shown.
5. Place the quadcopter upright on a flat surface and leave the aircraft still until the LED on the 4-in-1 control unit is solid blue (not blinking).



CAUTION: Always disconnect the Li-Po battery from the aircraft when not flying to avoid over-discharging the battery. Batteries discharged to a voltage lower than the lowest approved voltage may become damaged, resulting in loss of performance and potential fire when the batteries are charged.

Transmitter and Receiver Binding

The Glimpse quadcopter requires no radio-specific setup for basic flight. If you are using a computer transmitter, simply bind the quadcopter to your transmitter with the model type set to "Acro" or "Airplane" mode.

Binding is the process of programming the receiver to recognize the GUID (Globally Unique Identifier) code of a specific transmitter. You need to 'bind' your chosen *Spektrum*[™] or *DSM2*[®]/*DSMX*[®] technology equipped aircraft transmitter to the receiver for proper operation. If you purchased an RTF model, the transmitter is bound to the model at the factory.

To bind or re-bind your aircraft to your chosen transmitter, please follow the directions below.

General Binding Procedure

1. Disconnect the flight battery from the quadcopter.
2. Set the model type in your transmitter settings to "Acro" mode.
3. Center all trims on your transmitter.
4. Power off the transmitter and fully lower the throttle.
5. Connect the flight battery in the quadcopter. The blue LED on the 4-in-1 control unit flashes rapidly, indicating it is in bind mode.
6. Put the transmitter into bind mode while powering on the transmitter.
7. Release the bind button/switch after 2–3 seconds. The quadcopter is bound when the blue LED on the 4-in-1 control unit turns solid.
8. Disconnect the flight battery and power the transmitter off.



CAUTION: When using a Futaba[®] transmitter with a *Spektrum* module, you must reverse the throttle channel and rebind. Refer to your *Spektrum* module manual for binding and failsafe instructions. Refer to your Futaba transmitter manual for instructions on reversing the throttle channel.

MLP4DSM Binding Procedure

1. Disconnect the flight battery from the quadcopter.
2. Center all trims on your transmitter.
3. Power off the transmitter and fully lower the throttle.
4. Connect the flight battery in the quadcopter. The LED on the 4-in-1 control unit flashes red during initialization, then flashes blue when it is ready to bind.
5. When the blue light is flashing, push in and hold down the left stick while powering on the transmitter (you will hear a 'click').
6. Release the left stick. The transmitter will beep and the power LED will blink. The quadcopter is bound when the blue LED on the 4-in-1 control unit turns solid.
7. Disconnect the flight battery and power the transmitter off.

If you encounter problems, obey the binding instructions and refer to the troubleshooting guide for other instructions. If needed, contact the appropriate Horizon Product Support office. For a list of compatible DSM transmitters, please visit www.bindnfly.com.



Revolutionary SAFE® (Sensor Assisted Flight Envelope) technology uses an innovative combination of multi-axis sensors and software that allows model aircraft to know its position relative to the horizon. This spatial awareness is utilized to create a controlled flight envelope the aircraft uses to maintain a safe region of bank and pitch angles so you can fly more safely. Far beyond stability, this level of protection offers multiple modes so the pilot can choose to develop his or her skills with a greater degree of security and flight control that always feels crisp and responsive.

SAFE technology delivers:

- Flight envelope protection you can enable at the flip of a switch.
- Multiple modes to let you adapt SAFE technology to your skill level instantly.

Best of all, sophisticated SAFE technology doesn't require any work to enjoy. Every aircraft with SAFE technology is ready to use and optimized to offer the best possible flight experience.

FlySAFERC.com

Transmitter Control

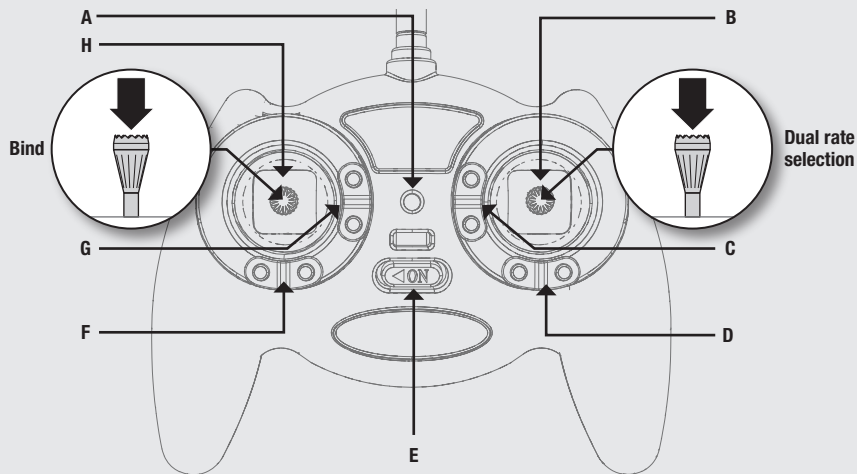

When pressed down, trim buttons make a sound that increases or decreases in pitch at each pressing. The middle or neutral trim position is heard as a middle tone in the pitch range of the sounds. The end of the control range is sounded by a series of beeps.

	A	B	C	D	E	F	G	H
Mode 1	Power LED indicator	Aileron (Left/Right) Throttle (Up/Down)	Throttle Trim	Aileron Trim	ON/OFF Switch	Rudder Trim	Eleva- tor Trim	Rudder (Left/Right) Elevator (Up/Down)
Mode 2	Power LED indicator	Aileron (Left/Right) Elevator (Up/ Down)	Eleva- tor Trim	Aileron Trim	ON/OFF Switch	Rudder Trim	Throttle Trim	Rudder (Left/Right) Throttle (Up/Down)

Rate Selection – RTF

The Glimpse™ RTF quadcopter comes with the Blade® MLP4DSM transmitter.

- When powered on, this transmitter is automatically high rate.
- Change rates by pressing and releasing the right control stick.
- In low-rate mode, the controls cannot reach their maximum values. This mode is typically preferred by pilots looking for smoother/easier control response during first time use.
- In high-rate mode, the controls can reach their maximum values. This mode is typically preferred by experienced pilots who are ready for fast forward flight and aerobatic maneuvers (loops, rolls, etc.).

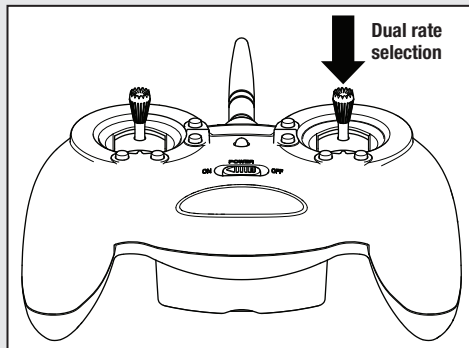

Understanding the Primary Flight Controls

If you are not familiar with the controls of your Glimpse quadcopter, take a few minutes to familiarize yourself with them before attempting your first flight.

Throttle

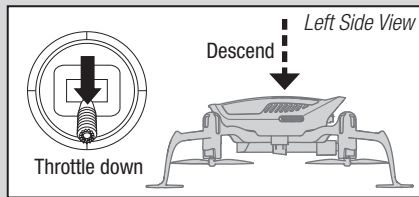
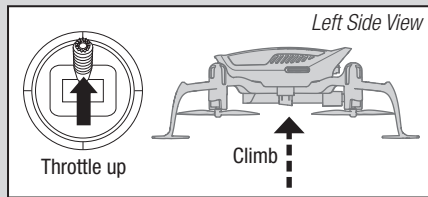

Rudder

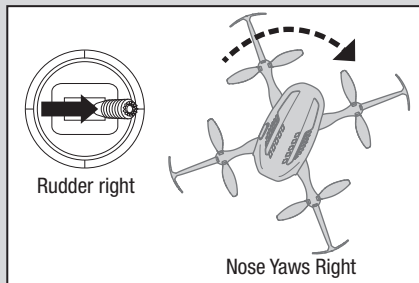
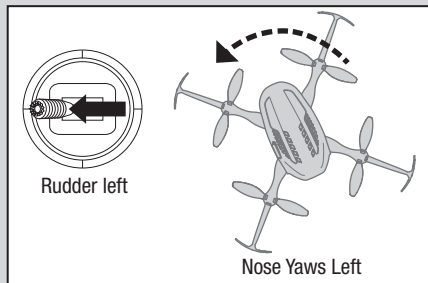

Elevator

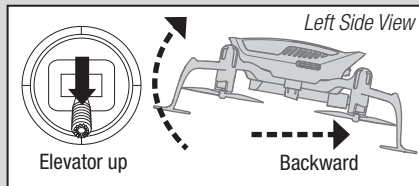
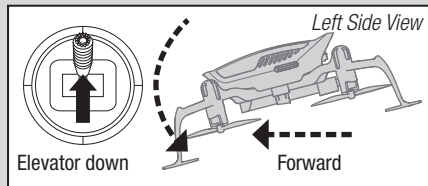

Aileron

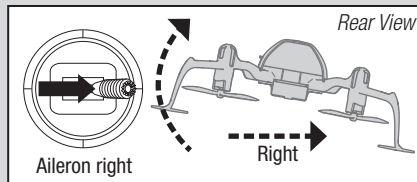
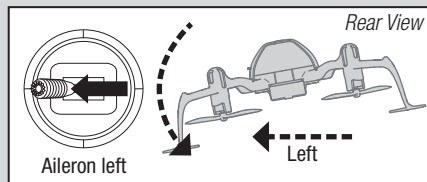

LED Codes

Equipment	LED Color	LED Status	Operation
Quadcopter	Blue	Rapid Blink	Bind Mode
		Slow Blink	No Link To Transmitter
		Solid	Stability Mode
	Red	Blink	Low Battery
RTF Transmitter	Red	Blink	Low Rate
		Solid	Hi Rate

Flying the Quadcopter

Takeoff

Increase the throttle until the model is approximately 2 ft. (600mm) off the ground in a low-level hover and concentrate on balancing the throttle stick's position so that the quadcopter holds a steady hover altitude. In some cases, you may need to make a few short "hops" to an altitude of just a few inches until you become familiar with the control inputs and trim settings required to maintain a steady hover and altitude.

Hovering

The Glimpse quadcopter requires minor throttle adjustments to maintain its altitude in hover. Remember to keep these throttle adjustments as minimal as possible. Large adjustments could result in a loss of control and/or a possible crash.

While attempting to establish a low-level hover, check to see if any trim adjustments are required to help keep the quadcopter from constantly drifting in various directions. If you find that it constantly drifts without any directional control input, land the model before making any adjustments to the trim settings.

- If the nose of the quadcopter rotates to the left or right, adjust the rudder trim.
- If the quadcopter continually drifts forward or backward, adjust the elevator trim.
- If the quadcopter continually drifts to the left or right, adjust the aileron trim.

Continue making minor trim adjustments until the machine hovers at a low altitude with very little drifting and directional control input. If this is your first multicopter or helicopter, seek the help of an experienced pilot to trim the model for you before making your first flight.

With your quadcopter properly trimmed and maintaining a stable low-level hover, practice using the rudder, elevator and aileron controls to familiarize yourself with the machine's responses to control inputs. Remember to keep the control inputs as minimal as possible.

NOTICE: Crash damage is not covered under warranty.

Low Voltage Cutoff (LVC)

Once the battery reaches 3V under load, the ESC will continuously lower power supplied to the motor until complete shutdown occurs. This helps prevent over-discharge of the Li-Po battery. Land immediately once the ESC activates LVC. Continuing to fly after LVC can damage the battery, cause a crash or both. Crash damage and batteries damaged due to over-discharge are not covered under warranty.

Repeatedly flying the aircraft until LVC activates will damage the flight battery.

Disconnect and remove the Li-Po battery from the aircraft after use to prevent trickle discharge. During storage, make sure the battery charge does not fall below 3V per cell.

Camera Control and App Function

- Download and install the Glimpse app to your 5.8GHz Wi-Fi capable smartphone or tablet by searching for “Glimpse” at the Apple App Store for your iOS device or at Google Play for your Android device.
- Power on your transmitter and the Glimpse.
- Open the Wi-Fi settings on your smartphone or tablet and connect to the Glimpse network (Glimpse_#####) using the password “12345678”.
- Open the Glimpse App on your smartphone or tablet.
- Place your smartphone in the transmitter holder as shown.
- Use the onscreen controls as shown on the following page to take photos and video.

Install the Phone Holder

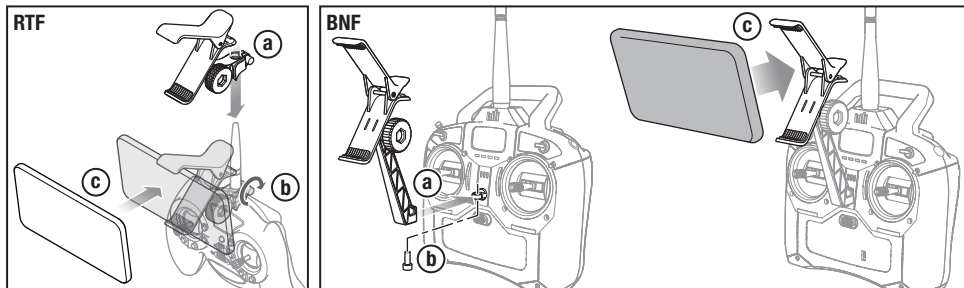

App Controls

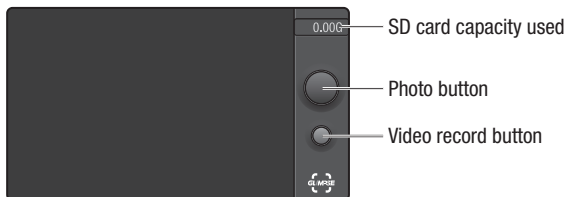

Retrieving Your Photos and Video

The Glimpse quadcopter comes with a micro SD card installed. To retrieve your photos and video from the micro SD card, you may do either of the following:

Remove the micro SD card.

- Press and release the micro SD card to remove it from the quadcopter.
- Insert the micro SD card into the provided SD card adapter.
- Insert the SD card adapter into an SD capable device.

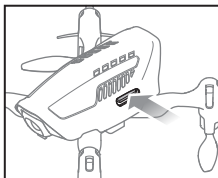

Connect a micro USB cable to the quadcopter.

- Insert a micro USB cable (not included) into the micro USB port located on the back of the quadcopter.

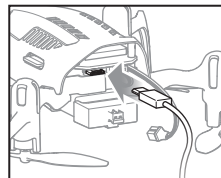

Post-Flight Inspection and Maintenance Checklist

✓	
Cleaning	Make sure the battery is not connected before cleaning. Remove dust and debris with a soft brush or a dry, lint-free cloth.
Motors	Replace the motor when the model will not fly steady or veers off when doing a climb out.
Wiring	Make sure the wiring does not block moving parts. Replace damaged wiring and loose connectors.
Fasteners	Make sure there are no loose screws, other fasteners or connectors. Do not over-tighten metal screws in plastic parts. Tighten screws so the parts are mated together, then turn screw only 1/8th of a turn more.
Propellers	Make sure there is no damage to the propellers or other parts that move at high speed. Damage to these parts includes cracks, burrs, chips or scratches. Replace damaged parts before flying.

Troubleshooting Guide

Problem	Possible Cause	Solution
Control response is inconsistent or requires extra trim to neutralize movement	Aircraft not initialized on a level surface	Disconnect the flight battery, center the control trim and re-initialize the quadcopter
	Battery not correctly placed in battery slot	Adjust battery position so quadcopter balances in the center of the frame
Will not respond to throttle	Throttle too high and/or throttle trim is too high	Reset controls with the throttle stick and throttle trim at the lowest setting
	Quadcopter moved during initialization	Disconnect the flight battery and re-initialize the quadcopter while keeping it from moving
	Throttle channel is reversed	Disconnect flight battery, reverse the throttle channel on the transmitter, reconnect flight battery
Does not function and smells burnt after connecting the flight battery	Flight battery connected with the wrong polarity	Replace the 4-in-1 board. Connect the flight battery noting proper polarity

Problem	Possible Cause	Solution
Reduced flight time or is underpowered	Flight battery charge is low	Completely recharge the flight battery
	Inadequate power to flight battery charger	Use a different USB power source for the charger
	Flight battery is damaged	Replace the flight battery and follow the flight battery instructions
	Flight conditions might be too cold	Make sure the battery is warm (room temperature) before use
LED on receiver flashes rapidly and quadcopter will not respond to transmitter (during binding)	Transmitter too near aircraft during binding process	Power off the transmitter. Move the transmitter a larger distance from the aircraft. Disconnect and reconnect the flight battery to the aircraft. Follow the binding instructions
	Bind switch or button was not held while transmitter was powered on	Power off transmitter and repeat bind process
	Aircraft or transmitter is too close to large metal object, wireless source or another transmitter	Move aircraft and transmitter to another location and attempt binding again
LED on the receiver flashes rapidly and the quadcopter will not respond to the transmitter (after binding)	Less than a 5-second wait between first powering on the transmitter and connecting the flight battery to the quadcopter	Leave the transmitter powered on. Disconnect and reconnect the flight battery to the quadcopter
	The quadcopter is bound to a different model memory (ModelMatch™ transmitters only)	Select the correct model memory on the transmitter. Disconnect and reconnect the flight battery to the quadcopter
	Flight battery or transmitter battery charge is too low	Replace or recharge batteries
	Aircraft or transmitter is too close to large metal object, wireless source or another transmitter	Move aircraft and transmitter to another location and attempt connecting again
Crashes immediately upon lift-off	Propellers in wrong locations or incorrect flight mode selected	Make necessary adjustments

Exploded View

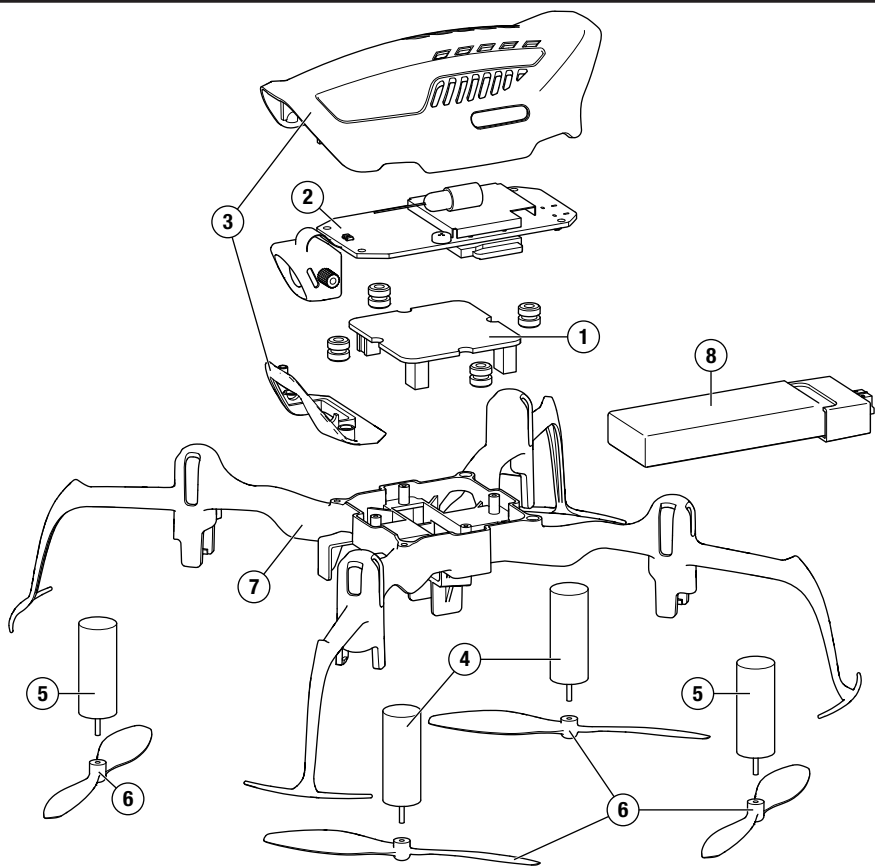

Parts Listings

Part #	Description
	BLH2200 Glimpse RTF
	BLH2280 Glimpse BNF
1	BLH2201 4-in-1 Control Unit: Glimpse
2	BLH2202 Camera Board: Glimpse
3	BLH2203 Canopy: Glimpse
4	BLH2204 Clockwise Motor: Glimpse

Part #	Description
5	BLH2205 Counter-Clockwise Motor: Glimpse
6	BLH2206 Props (4): Glimpse
7	BLH2207 Main Frame: Glimpse
8	EFLB-5001S25UM 500mAh 1S 3.7V 25C LiPo High Current UMX Connector

Optional Parts

Part #	Description
	DXe DSMX Transmitter Only
	DX6e DSMX 6-Channel Transmitter Only
	DX6 DSMX 6-Channel Transmitter Only
	DX8 DSMX 8-Channel Transmitter Only

Part #	Description
	DX9 DSMX 9-Channel Transmitter Only
	iX12 DSMX 12-Channel Transmitter Only
	DX20 DSMX 20-Channel Transmitter Only
	DX18 DSMX 18-Channel Transmitter Only

Limited Warranty

What this Warranty Covers

Horizon Hobby, LLC, (Horizon) warrants to the original purchaser that the product purchased (the "Product") will be free from defects in materials and workmanship at the date of purchase.

What is Not Covered

This warranty is not transferable and does not cover (i) cosmetic damage, (ii) damage due to acts of God, accident, misuse, abuse, negligence, commercial use, or due to improper use, installation, operation or maintenance, (iii) modification of or to any part of the Product, (iv) attempted service by anyone other than a Horizon Hobby authorized service center, (v) Product not purchased from an authorized Horizon dealer, (vi) Product not compliant with applicable technical regulations, or (vii) use that violates any applicable laws, rules, or regulations.

OTHER THAN THE EXPRESS WARRANTY ABOVE, HORIZON MAKES NO OTHER WARRANTY OR REPRESENTATION, AND HEREBY DISCLAIMS ANY AND ALL IMPLIED WARRANTIES, INCLUDING, WITHOUT LIMITATION, THE IMPLIED WARRANTIES OF NON-INFRINGEMENT, MERCHANTABILITY AND FITNESS FOR A PARTICULAR PURPOSE. THE PURCHASER ACKNOWLEDGES THAT THEY ALONE HAVE DETERMINED THAT THE PRODUCT WILL SUITABLY MEET THE REQUIREMENTS OF THE PURCHASER'S INTENDED USE.

Purchaser's Remedy

Horizon's sole obligation and purchaser's sole and exclusive remedy shall be that Horizon will, at its option, either (i) service, or (ii) replace, any Product determined by Horizon to be defective. Horizon reserves the right to inspect any and all Product(s)

involved in a warranty claim. Service or replacement decisions are at the sole discretion of Horizon. Proof of purchase is required for all warranty claims. SERVICE OR REPLACEMENT AS PROVIDED UNDER THIS WARRANTY IS THE PURCHASER'S SOLE AND EXCLUSIVE REMEDY.

Limitation of Liability

HORIZON SHALL NOT BE LIABLE FOR SPECIAL, INDIRECT, INCIDENTAL OR CONSEQUENTIAL DAMAGES, LOSS OF PROFITS OR PRODUCTION OR COMMERCIAL LOSS IN ANY WAY, REGARDLESS OF WHETHER SUCH CLAIM IS BASED IN CONTRACT, WARRANTY, TORT, NEGLIGENCE, STRICT LIABILITY OR ANY OTHER THEORY OF LIABILITY, EVEN IF HORIZON HAS BEEN ADVISED OF THE POSSIBILITY OF SUCH DAMAGES. Further, in no event shall the liability of Horizon exceed the individual price of the Product on which liability is asserted. As Horizon has no control over use, setup, final assembly, modification or misuse, no liability shall be assumed nor accepted for any resulting damage or injury. By the act of use, setup or assembly, the user accepts all resulting liability. If you as the purchaser or user are not prepared to accept the liability associated with the use of the Product, purchaser is advised to return the Product immediately in new and unused condition to the place of purchase.

Law

These terms are governed by Illinois law (without regard to conflict of law principals). This warranty gives you specific legal rights, and you may also have other rights which vary from state to state. Horizon reserves the right to change or modify this warranty at any time without notice.

WARRANTY SERVICES

Questions, Assistance, and Services

Your local hobby store and/or place of purchase cannot provide warranty support or service. Once assembly, setup or use of the Product has been started, you must contact your local distributor

or Horizon directly. This will enable Horizon to better answer your questions and service you in the event that you may need any assistance. For questions or assistance, please visit our website at www.horizonhobby.com, submit a Product Support Inquiry, or call the toll free telephone number referenced in the Warranty and Service Contact Information section to speak with a Product Support representative.

Inspection or Services

If this Product needs to be inspected or serviced and is compliant in the country you live and use the Product in, please use the Horizon Online Service Request submission process found on our website or call Horizon to obtain a Return Merchandise Authorization (RMA) number. Pack the Product securely using a shipping carton. Please note that original boxes may be included, but are not designed to withstand the rigors of shipping without additional protection. Ship via a carrier that provides tracking and insurance for lost or damaged parcels, as Horizon is not responsible for merchandise until it arrives and is accepted at our facility. An Online Service Request is available at http://www.horizonhobby.com/content/service-center_render-service-center. If you do not have internet access, please contact Horizon Product Support to obtain a RMA number along with instructions for submitting your product for service. When calling Horizon, you will be asked to provide your complete name, street address, email address and phone number where you can be reached during business hours. When sending product into Horizon, please include your RMA number, a list of the included items, and a brief summary of the problem. A copy of your original sales receipt must be included for warranty consideration. Be sure your name, address, and RMA number are clearly written on the outside of the shipping carton. NOTICE: Do not ship LiPo batteries to Horizon. If you have any issue with a LiPo battery, please contact the appropriate Horizon Product Support office.

Warranty Requirements

For Warranty consideration, you must include your original sales receipt verifying the proof-of-purchase date. Provided warranty conditions have been met, your Product will be serviced or replaced free of charge. Service or replacement decisions are at the sole discretion of Horizon.

Non-Warranty Service

Should your service not be covered by warranty, service will be completed and payment will be required without notification or estimate of the expense unless the expense exceeds 50% of the retail purchase cost. By submitting the item for service you are agreeing to payment of the service without notification. Service estimates are available upon request. You must include this request with your item submitted for service. Non-warranty service estimates will be billed a minimum of ½

hour of labor. In addition you will be billed for return freight. Horizon accepts money orders and cashier's checks, as well as Visa, MasterCard, American Express, and Discover cards. By submitting any item to Horizon for service, you are agreeing to Horizon's Terms and Conditions found on our website http://www.horizonhobby.com/content/service-center_render-service-center.

ATTENTION: Horizon service is limited to Product compliant in the country of use and ownership. If received, a non-compliant Product will not be serviced. Further, the sender will be responsible for arranging return shipment of the un-serviced Product, through a carrier of the sender's choice and at the sender's expense. Horizon will hold non-compliant Product for a period of 60 days from notification, after which it will be discarded. 10/15

Warranty and Service Contact Information

Country of Purchase	Horizon Hobby	Contact Information	Address
United States of America	Horizon Service Center (Repairs and Repair Requests)	servicecenter.horizonhobby.com/ RequestForm/	4105 Fieldstone Rd Champaign, Illinois, 61822 USA
	Horizon Product Support (Product Technical Assistance)	productsupport@horizonhobby.com	
		877-504-0233	
Sales		websales@horizonhobby.com	
		800-338-4639	
EU	Horizon Technischer Service	service@horizonhobby.eu	Hanskampring 9 D 22885 Barsbüttel, Germany
	Sales: Horizon Hobby GmbH	+49 (0) 4121 2655 100	

FCC Information

This equipment has been tested and found to comply with the limits for Part 15 of the FCC rules. These limits are designed to provide reasonable protection against harmful interference in a residential installation. This equipment generates uses and can radiate radio frequency energy and, if not installed and used in accordance with the instructions, may cause harmful interference to radio communications.

However, there is no guarantee that interference will not occur in a particular installation. If this equipment does cause harmful

This device complies with part 15 of the FCC rules. Operation is subject to the following two conditions:

1. This device may not cause harmful interference.
2. This device must accept any interference received, including interference that may cause undesired operation.



CAUTION: Changes or modifications not expressly approved by the party responsible for compliance could void the user's authority to operate the equipment.

This product contains a radio transmitter with wireless technology which has been tested and found to be compliant with the applicable regulations governing a radio transmitter in the 2.400GHz to 2.4835GHz frequency range.

IC Information

This device complies with Industry Canada license-exempt RSS standard(s). Operation is subject to the following two conditions: (1) this device may not cause interference, and (2)

interference to radio or television reception, which can be determined by turning the equipment off and on, the user is encouraged to try to correct the interference by one or more of the following measures:

- Reorient or relocate the receiving antenna.
- Increase the separation between the equipment and receiver.
- Connect the equipment to an outlet on a circuit different from that to which the receiver is connected.

Antenna Separation Distance

When operating your Spektrum transmitter, please be sure to maintain a separation distance of at least 20 cm between your body (excluding fingers, hands, wrists, ankles and feet) and the antenna to meet RF exposure safety requirements as determined by FCC regulations.

The illustrations show the approximate 20 cm RF exposure area and typical hand placement when operating your Spektrum transmitter.

this device must accept any interference, including interference that may cause undesired operation of the device.

Compliance Information for the European Union



Horizon Hobby, LLC hereby declares that this product is in compliance with the essential requirements and other relevant provisions of the RED and EMC Directives.

A copy of the EU Declaration of Conformity is available online at:
<http://www.horizonhobby.com/content/support-render-compliance>.

Instructions for disposal of WEEE by users in the European Union

This product must not be disposed of with other waste. Instead, it is the user's responsibility to dispose of their waste equipment by handing it over to a designated collections point for the recycling of waste electrical and electronic equipment. The separate collection and recycling of your waste equipment at the time of disposal will help to conserve natural resources and ensure that it is recycled in a manner that protects human health and the environment. For more information about where you can drop off your waste equipment for recycling, please contact your local city office, your household waste disposal service or where you purchased the product.



©2018 Horizon Hobby, LLC.

Blade, E-flite, Glimpse, SAFE, the SAFE logo, DSM2, DSMX, Bind-N-Fly, the BNF logo, ModelMatch and the Horizon Hobby logo are trademarks or registered trademarks of Horizon Hobby, LLC.

The Spektrum trademark is used with permission of Bachmann Industries, Inc. Futaba is a registered trademark of Futaba Denshi Kogyo Kabushiki Kaisha Corporation of Japan. All other trademarks, service marks or logos are property of their respective owners.

Patents pending.

Created 01/18 47233.3 BLH2200, BLH2280